

BUILD-A-BORZ

Home Workshop Machine Pistol



Самодельный Борз
пистолет-пулемет

Practical Scrap Metal Small Arms Vol.9



Practical Scrap Metal Small Arms Vol.9
By Professor Parabellum

Introduction



The simple machine pistol detailed here is very similar to other widely tried-and-tested expedient designs in circulation, though improved upon in terms of compactness, handling and ease of availability of materials required. It's essentially a homebuilt version of the Armenian K6-92, a compact machine pistol widely copied in the early 1990s by various separatist groups following the breakup of the Soviet Union. The commercial counterpart was chambered in 9x18 Makarov, though the general design adapts well to .380 or 9x19. This basic simplified version uses 9mm STEN magazines and includes an adaptable bolt weight system in it's design. Construction does not require a lathe or milling machine and only very basic tools may be used.



*For legal reasons the prototype shown was constructed as a non-firing legal dummy display model for purposes of demonstration. It has a blocked and destroyed dummy barrel and it's bolt contains no provisions for a firing pin. **This document is presented purely for academic study purposes only.***

Bolt construction



The bolt used in this design is a laminated assembly consisting of two sections of steel box tube and bar stock, either held in place via thick steel pins or permanently welded together. Additional bolt mass is provided by way of a 3" x 1" steel plate which rides above the receiver, also doubling as a cocking handle. It's possible to stack further plates on top of the assembly, each adding around 100g extra weight.

Barrel



The barrel is assembled in an identical manor to the bolt and includes a reliable integrated feed ramp formed into it's square tubing collar. All three parts can be held in place via several steel pins or be permanently welded together.

Trigger group



The trigger group consists of two pieces cut from 6mm thick steel plate which rock up or down under spring tension, either allowing the bolt to pass or be held back. The trigger housing is constructed from three pieces of steel plate and is welded onto the receiver once complete.

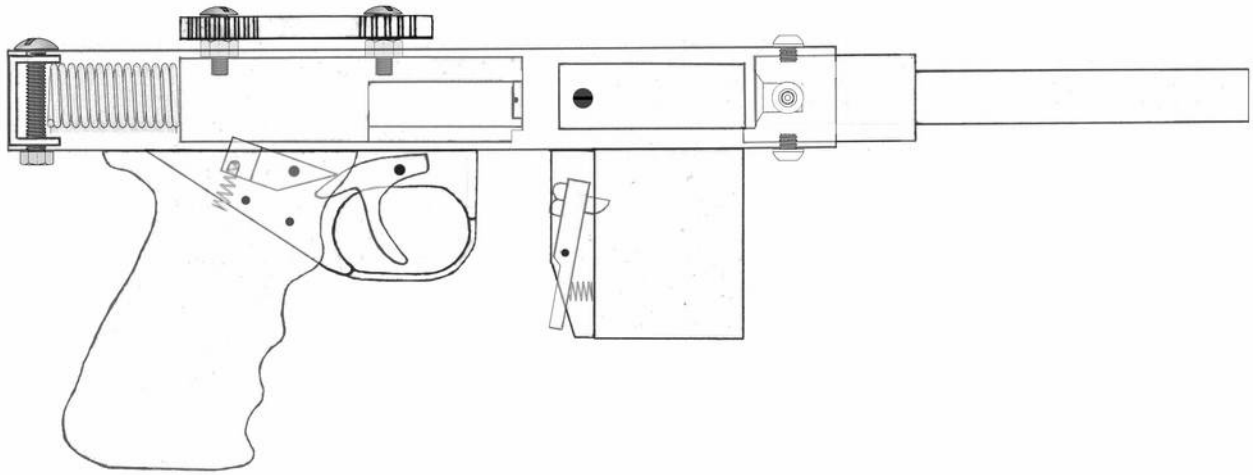

Tools:

Drill press
Cobalt tipped drill bits (Optional)
Welder
Angle grinder + 1mm slitting disc
Dremel / Rotary tool + grinding bits
Hand files
Hacksaw

Materials:

30mm x 30mm x 2mm wall mild steel box section tube
25mm x 25mm x 2mm wall mild steel box section tube
20mm x 20mm x 2mm wall mild steel box section tube
25mm x 50mm x 2mm (1" x 2") rectangular box section tube
6mm thick (1 1/4") mild steel plate
2mm or 3mm thick mild steel plate
16mm (5/8") mild steel round bar stock
1 1/2" thick hardwood or plastic

Plans

All pages included should be printed out on 8.5 x 11 US letter paper. Each component template is drawn to scale and can be cut out and glued to their respective thickness of material. Make sure the ruler at the bottom left of each sheet is 2 inches in length. Alternatively, enlarge the plans using a computer program until the ruler is the correct length, then trace the parts needed onto a sheet of paper taped over your computer's screen.

Receiver

30mm x 30mm
square mild steel
box tube
x 2mm thick wall

247mm long

Top:

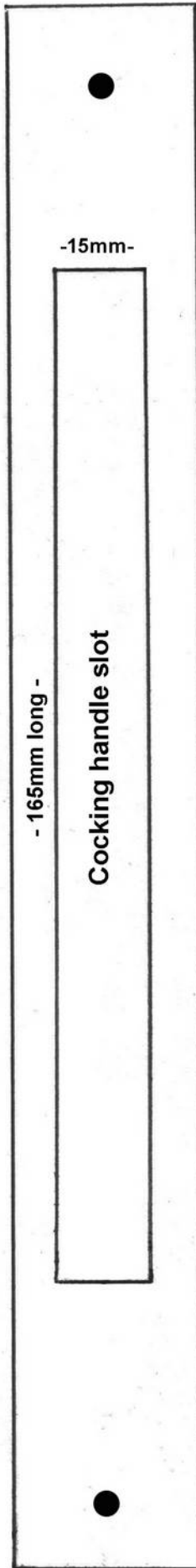

Right side:

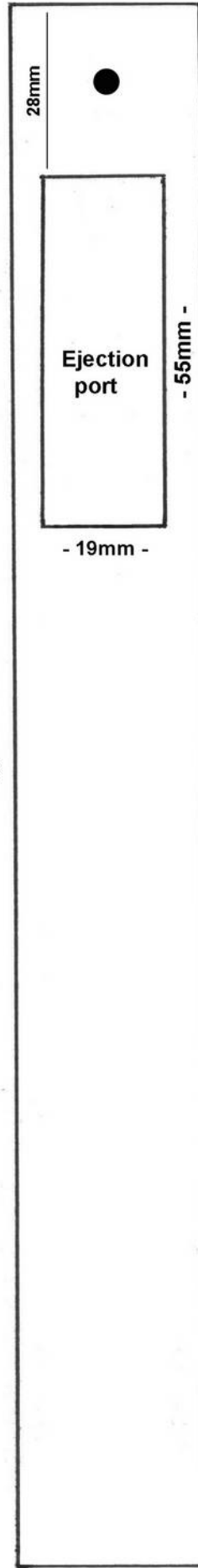

Left side:

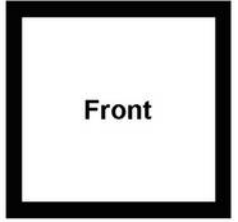
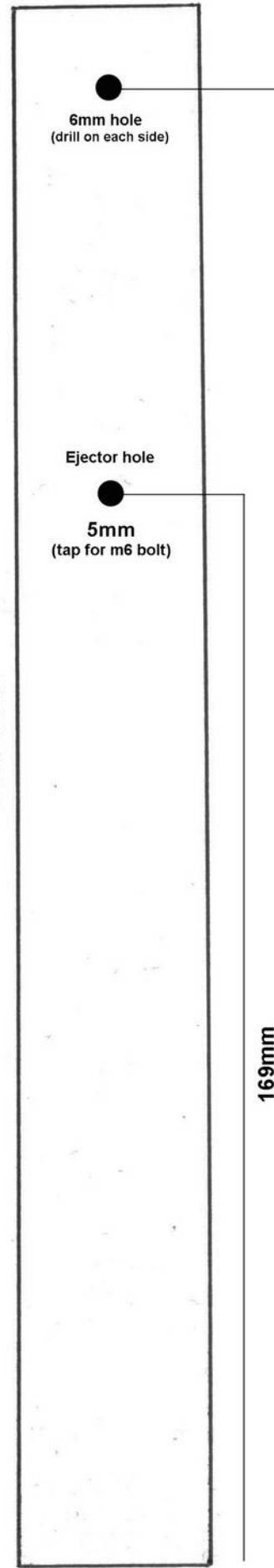

2 inches

Receiver Pt.2

Bottom

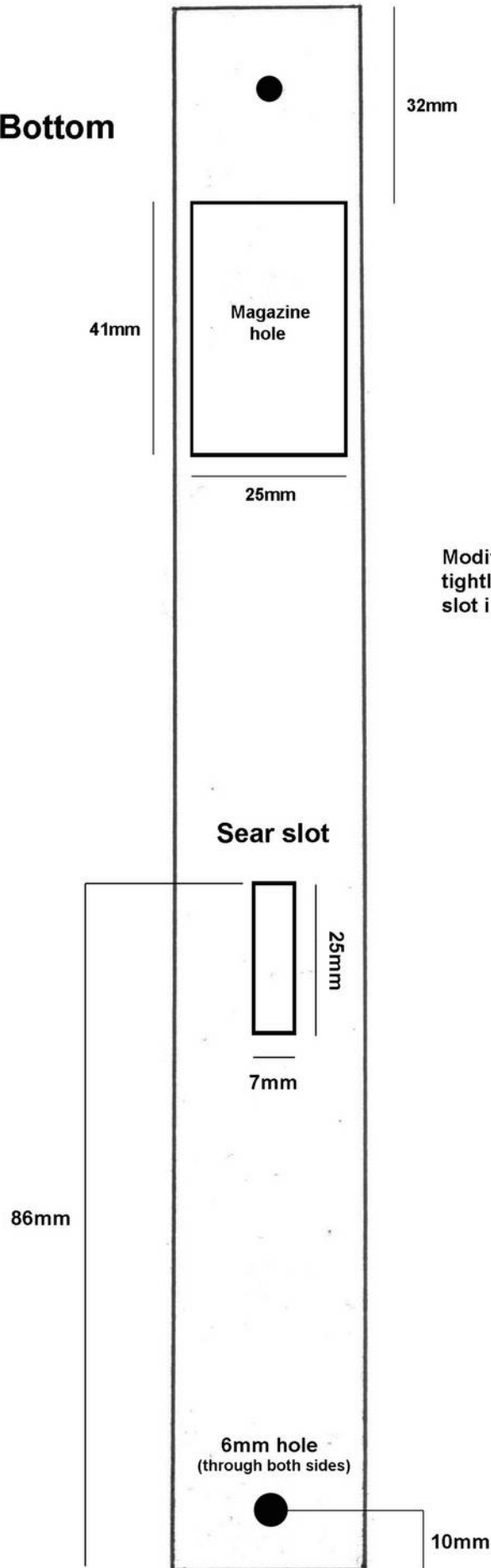

Ejector

Modify a 1/2" long m6 bolt into a blade profile. Screw tightly into the ejector hole until aligned with slot in bolt. Apply loctite to fully secure.

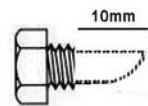

2 inches

Trigger housing

Template:

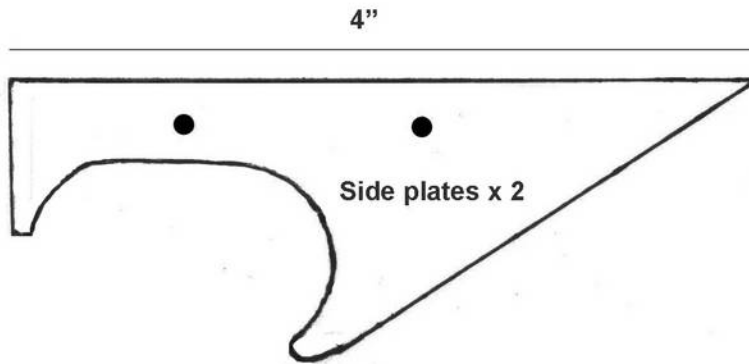

Bend a 70mm length of 6mm wide mild steel strip (2mm thick) to profile below:

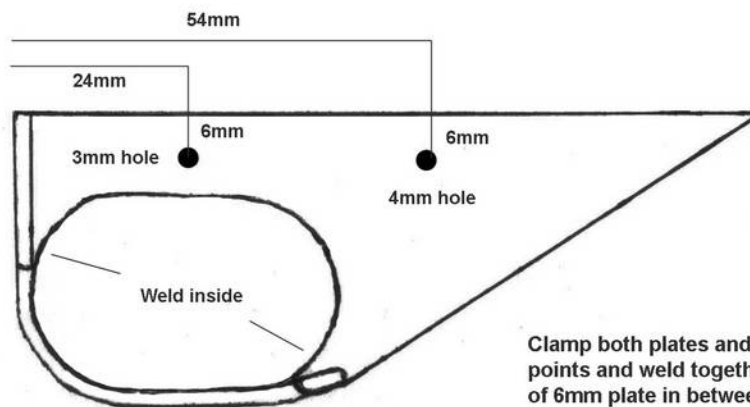
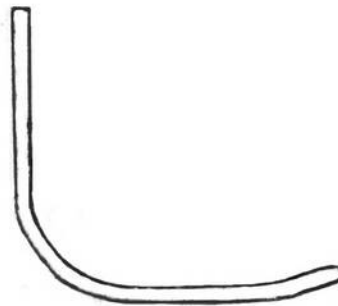

Clamp both plates and trigger guard together at contact points and weld together inside trigger guard. insert a piece of 6mm plate in between to assist.

Drill holes once welded to ensure accurate alignment.

2 inches

Trigger & sear

Cut from 6mm thick (1/4") mild steel plate

Trigger template:

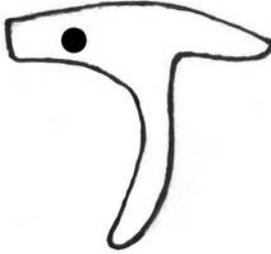

Sear:

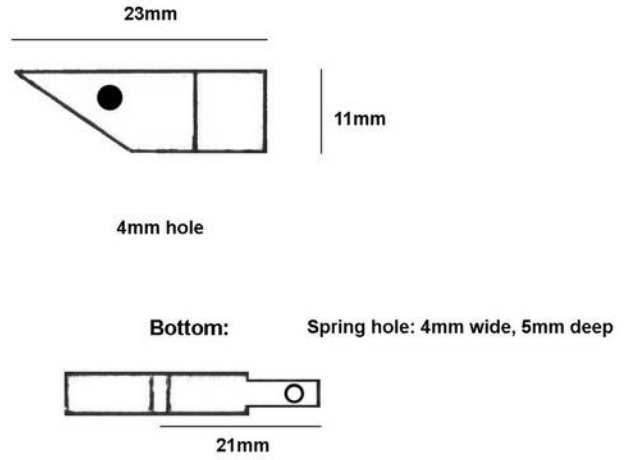

Assembled:

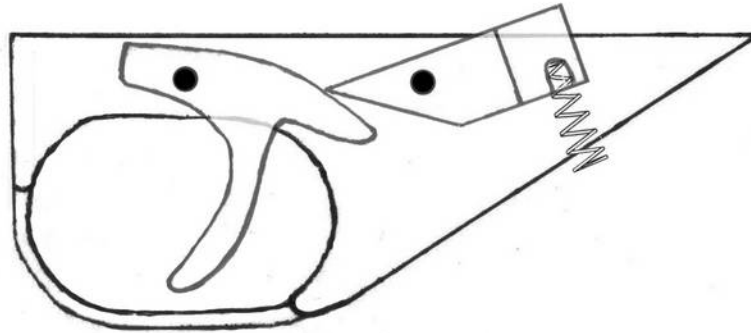

Manipulate spring with pliers until snug in hole in sear

5mm wide x 15mm long



Trigger accepts a 15mm long m3 bolt + nut

Sear accepts a 10mm pin or headless section of m4 bolt

2 inches

Magazine-well (for STEN magazines)

A 57mm length of 1" x 2" (25mm x 50mm x 2mm wall) steel rectangular tube is modified by removing a single 1" side to enable both 2" sides to be flared out slightly in order to accept a STEN magazine. A section of 1" steel bar can be hammered down through the opened side to achieve this. The removed side is then welded back into place forming the correct inner dimensions. Use a STEN magazine for reference throughout.

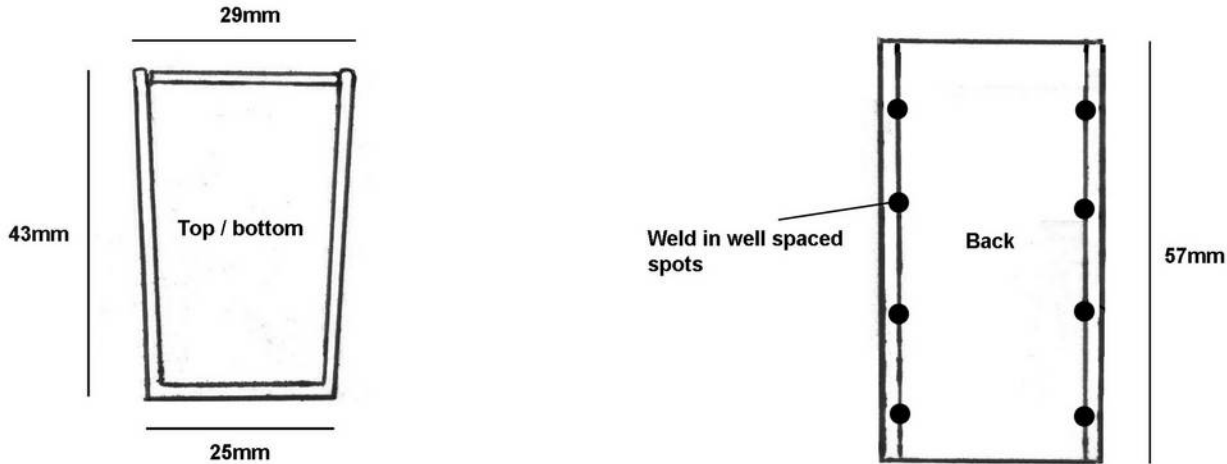

Magazine catch housing

Made using 15mm wide steel box tube or bent from 16swg steel sheet.

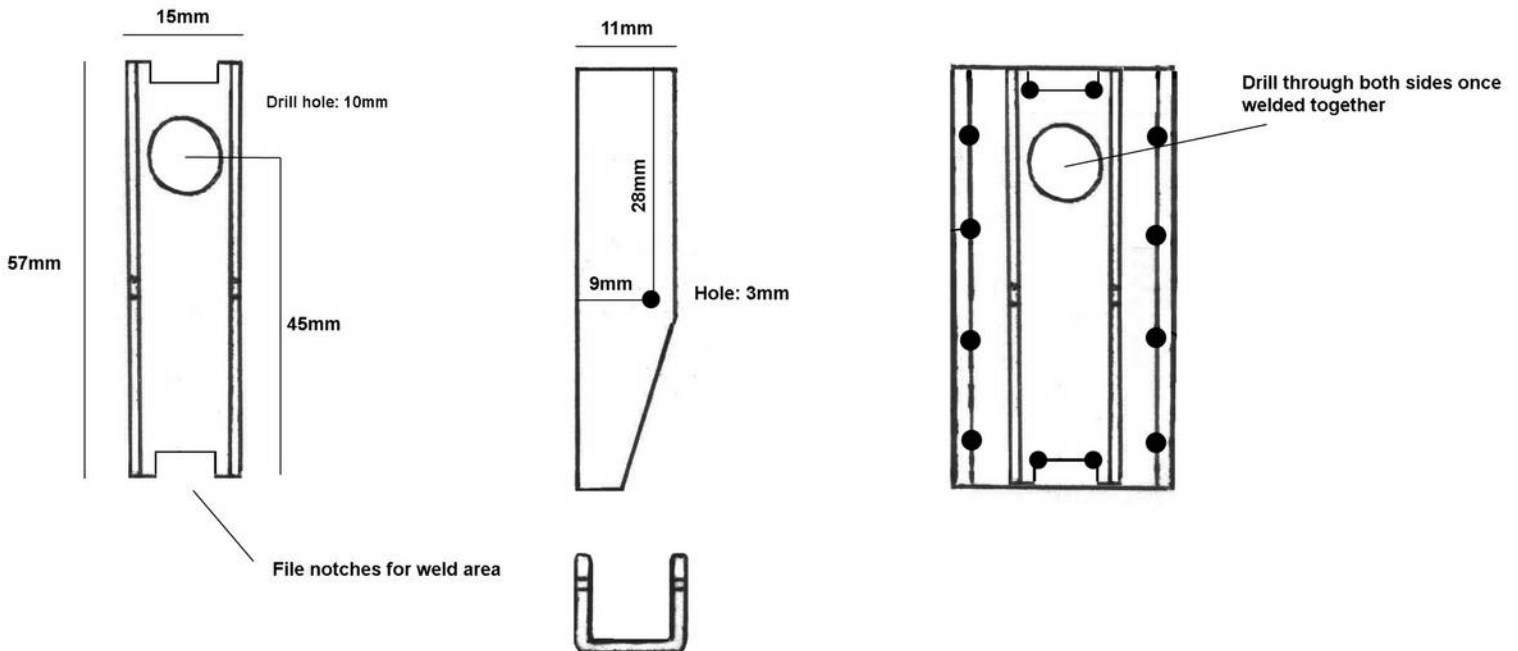

2 inches

Magazine latch

Assemble from a strip of 6mm (1/4") thick aluminum or plastic plate + M6 bolt

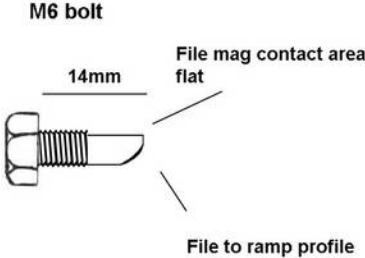
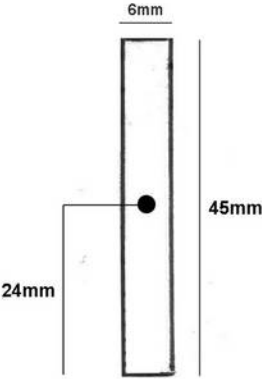
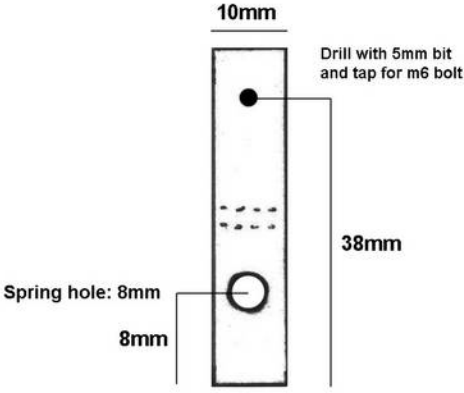

Tightly screw into plate and modify as above while in place.

Catch spring: compression / 10mm wide, 15mm long

Finished:

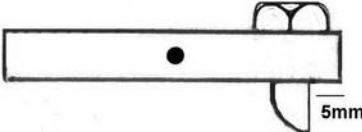

File down contact area until snug against top of hole in magazine.

Attach to magazine well using 15mm long M3 bolt = nut

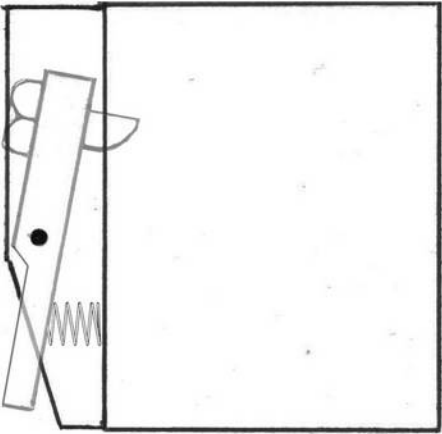

2 inches

Alternative magazine-well + STEN mag modifications

A length of 20mm x 40mm steel rectangular box tube with a wall thickness of 2mm will facilitate a magazine made from 15mm x 30 / 35mm tube.

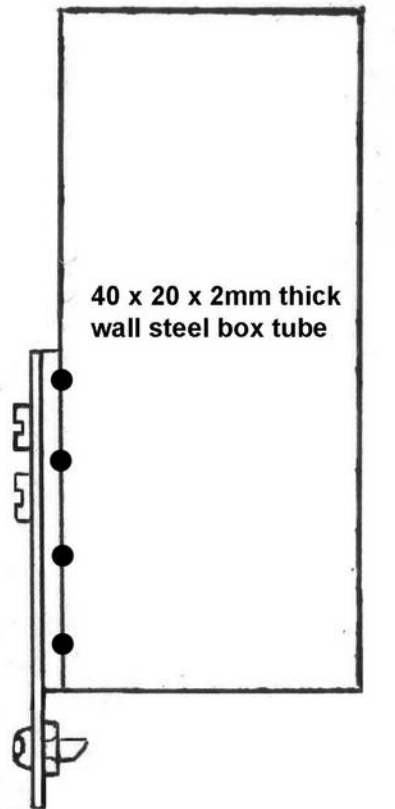

Mounting tab
3mm thick mild steel

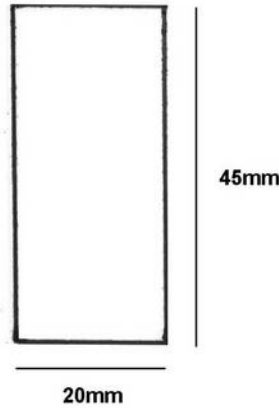

M5 bolt
14mm

- File magazine contact edge flat
- Form ramp profile on underside
- Retain with an m5 nut + loctite

Spring steel strip
(Cut from a section of handsaw blade)

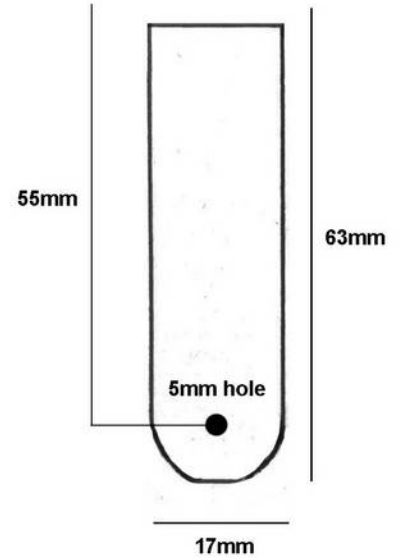

Bolt latch strip to mounting tab and weld assembly to back of magazine well.

Position to drill catch hole in STEN magazine

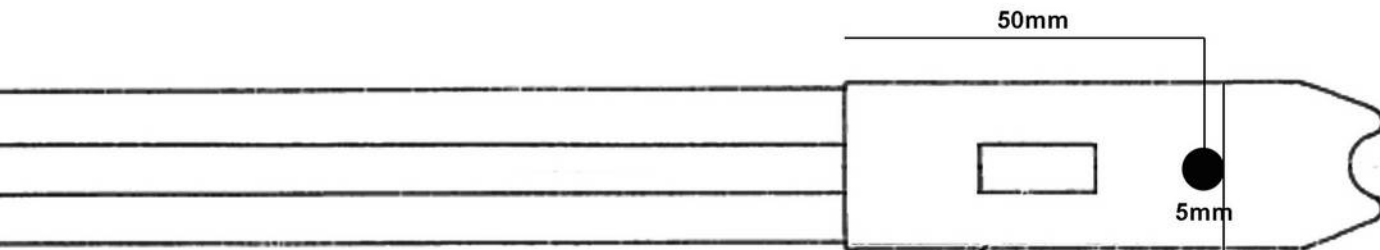

Grind with dremel until catch makes contact here (52mm from mag shoulder)

2 inches

Homemade 9mm magazine

To form the magazine spring, tightly wind a length of 20 gauge spring steel wire around a 15" long 24mm x 8mm bar leaving a 15mm gap between coils - once complete cut spring to 12" long

Body is constructed from 35mm x 15mm (1.5mm wall) mild steel box tube - 7" in length

Lips should be bent inwards until spaced 9mm apart and able to retain a cartridge

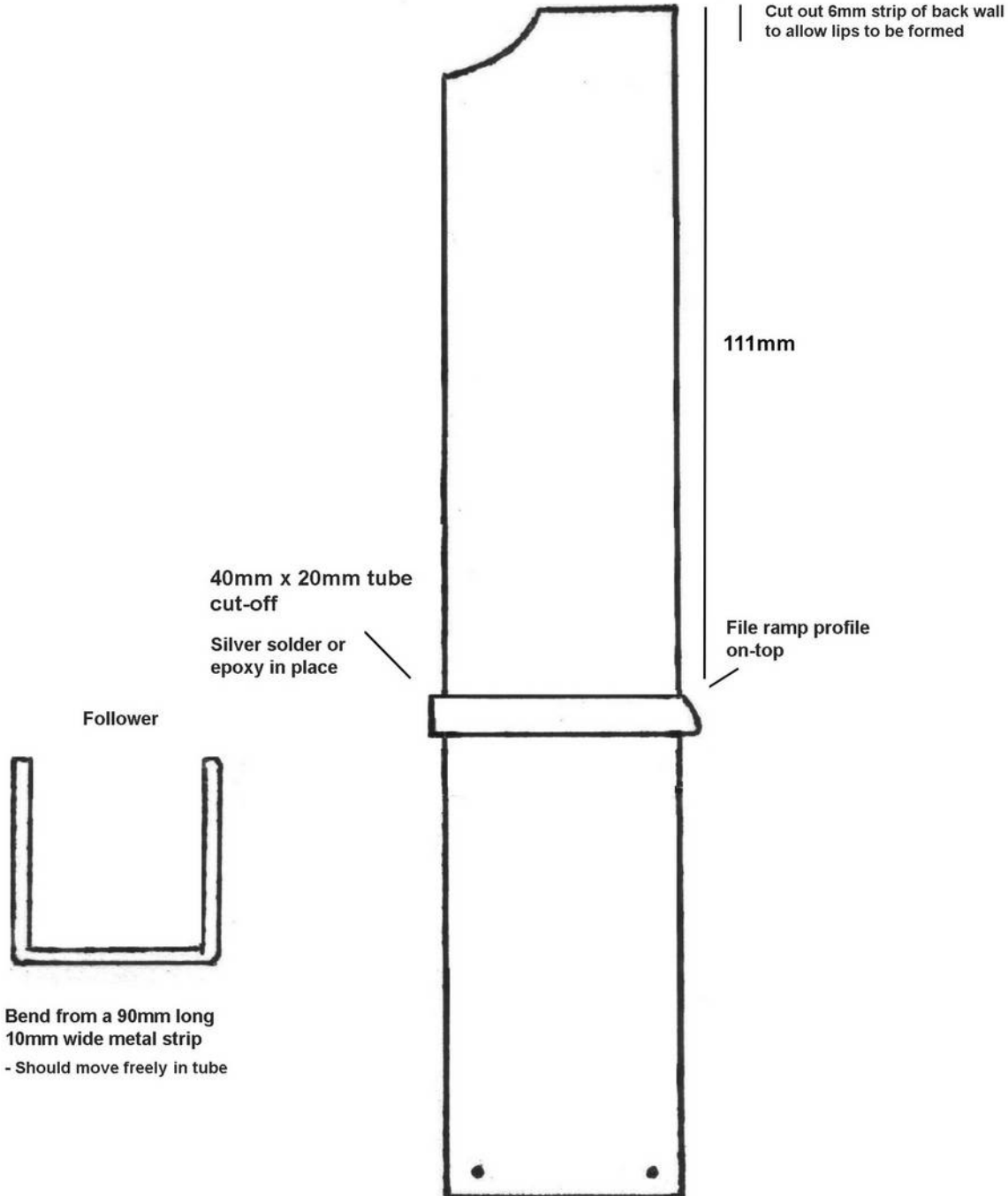

2 inches

A 12mm x 32mm steel strip behind two pins retains the assembly

.380 ACP / 9x18 Makarov magazine

Rather than hand winding a magazine spring, a 12mm wide, 2.5" long tension spring can be stretched out to form a very long compression spring suitable for use in such a small ID magazine.

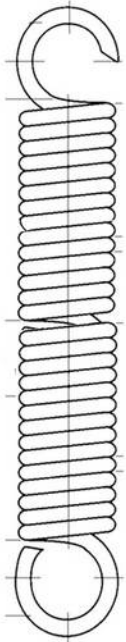

Hold both ends using pliers in each hand - stretch out until a consistent compression spring is formed. Snip both ends once complete.

A magazine spring produced in this manor will work reliably providing it is used in 30mm x 15mm tube sizes or smaller.

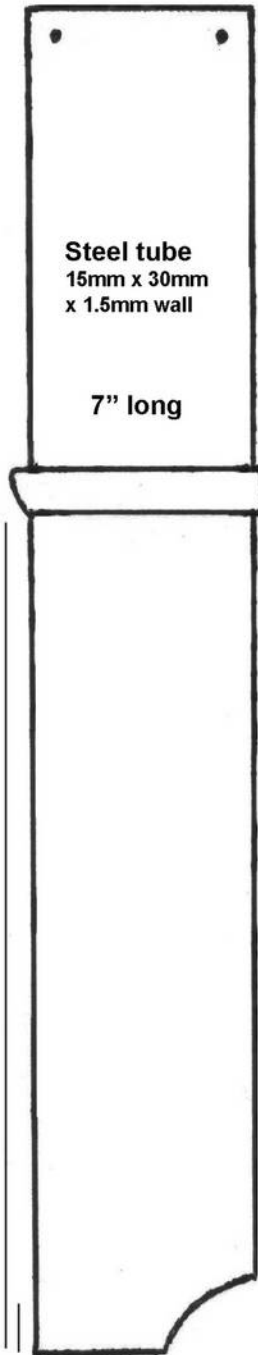

Base plate - 12mm x 27mm steel strip
- secure with two pins

Steel tube
15mm x 30mm
x 1.5mm wall

7" long

Weld or epoxy a 3" long, 4mm thick steel strip to the upper half of the back of the magazine tube to fit in a magazine-well made from 40mm x 20mm x 2mm tube.

File to ramp shape

111mm

Cut away a 6mm section from back

Follower

Bend from 90mm long steel strip
10mm wide x 2mm thick

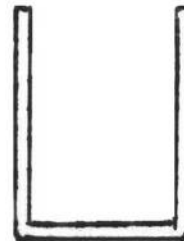

Bend lips inwards evenly until both tips retain a cartridge
- sand edges smooth

2 inches

Bolt (Tube body section)

The three piece bolt assembly is laminated together from a 4" long length of 25mm x 2mm steel square tube sleeved with a length of 20mm x 2mm to accept a 16mm diameter steel bar to serve as a bolt face.

The 20mm ID section of tube may need to be increased in outside diameter by lightly 'spattering' some weld on each side and grinding down even until a tight fit is achieved. If available, 25mm x 2.5mm tube will be a better fit.

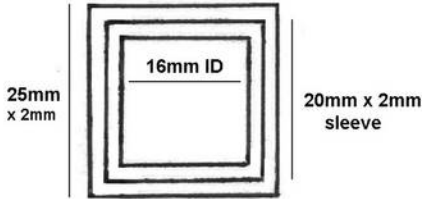

Bottom:

4"

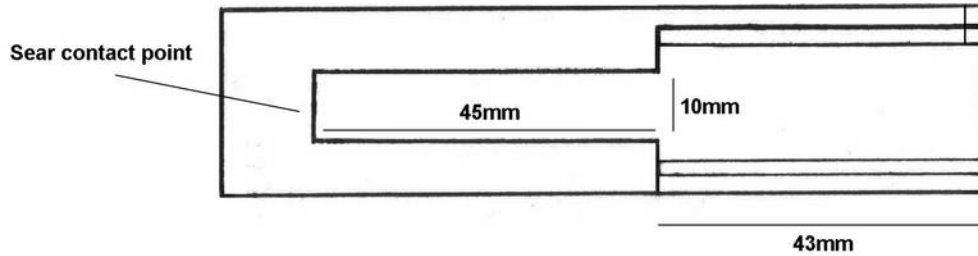

Left side:

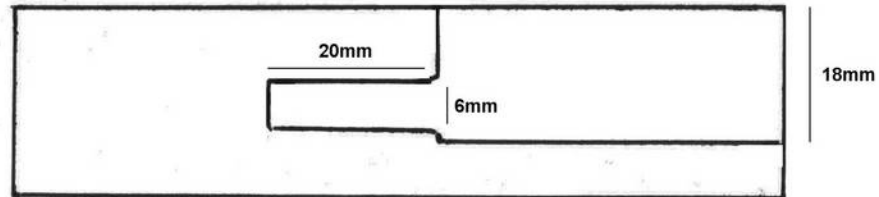

Right side:

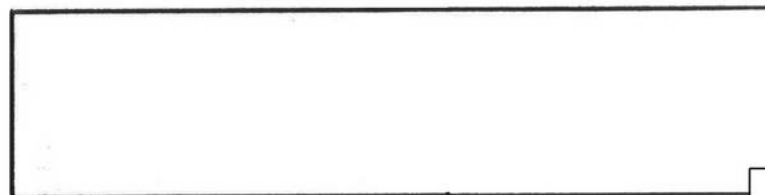

Cut a 5mm x 5mm square out of bottom corner to accomodate for feed ramp

2 inches

Bolt Pt.2

A 4" long section of 16mm diameter mild steel bar stock serves as the inner section of the bolt.



- Drill the center with a 10mm drill bit until 3mm deep. Level the hole flat using a 10mm drill bit having had it's tip removed using an angle grinder.
- Bevel the rim inwards slightly using a 16mm+ drill bit and sand smooth.

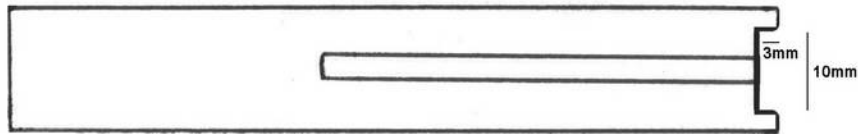

Using an angle grinder fitted with a 1mm slitting disc, make a 60mm long slot in the left side, 5mm deep.

Weight / cocking handle

A 3" by 1" rectangle cut from 6mm (1 1/4") mild steel plate serves as a cocking handle and adds additional mass to the bolt. Each plate will weigh around 100g.

Secure using two 1" long m5 bolts tapped into bolt and spaced though cocking handle slot with an m6 nut

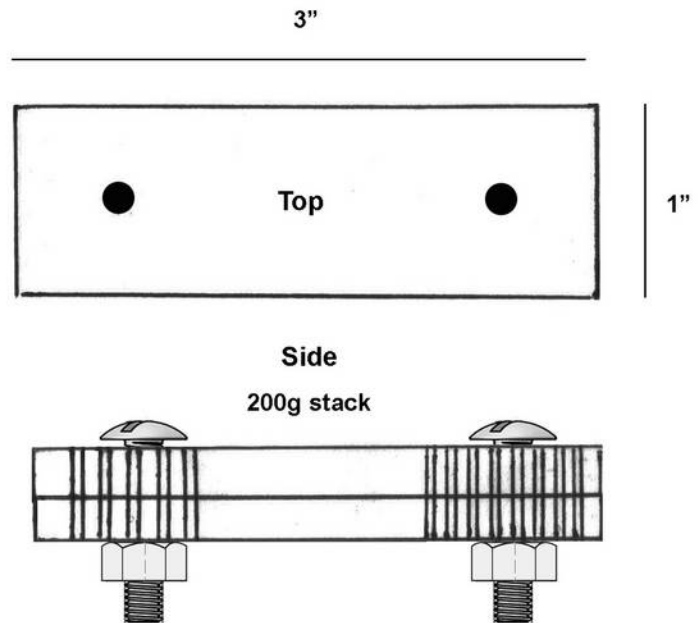

- Make serrations on sides using a hacksaw to improve grip

2 inches

Bolt (assembled)

Front:

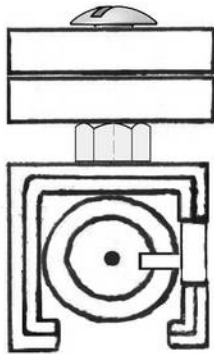

Left side

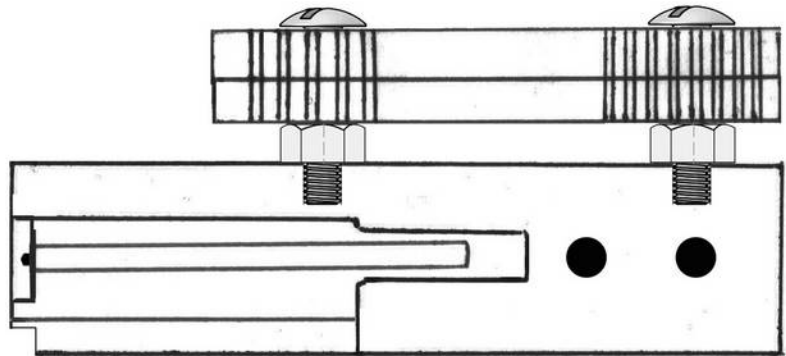

Secure inner bolt piece into carrier tube via two 6mm x 25mm steel pins. Alternatively drill and tap for two m8 grub screws either side. Weld in corners at rear to secure beforehand.

Back plug

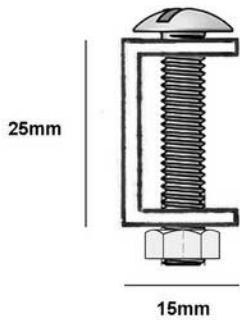

The back plug can simply be a 15mm length of 25mm diameter steel bar stock drilled for a bolt. Alternatively, a section of 25mm box section can be cut in half to serve as a plug. Secure through receiver with a 35mm long m6 bolt + nut.

Recoil spring

4 3/4" (120mm)

Unmodified purchased compression spring

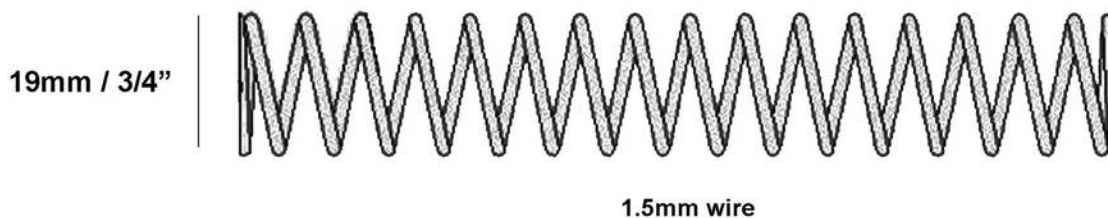

2 inches

Finish all components using a matt black
'high temperature engine enamel' type spray paint

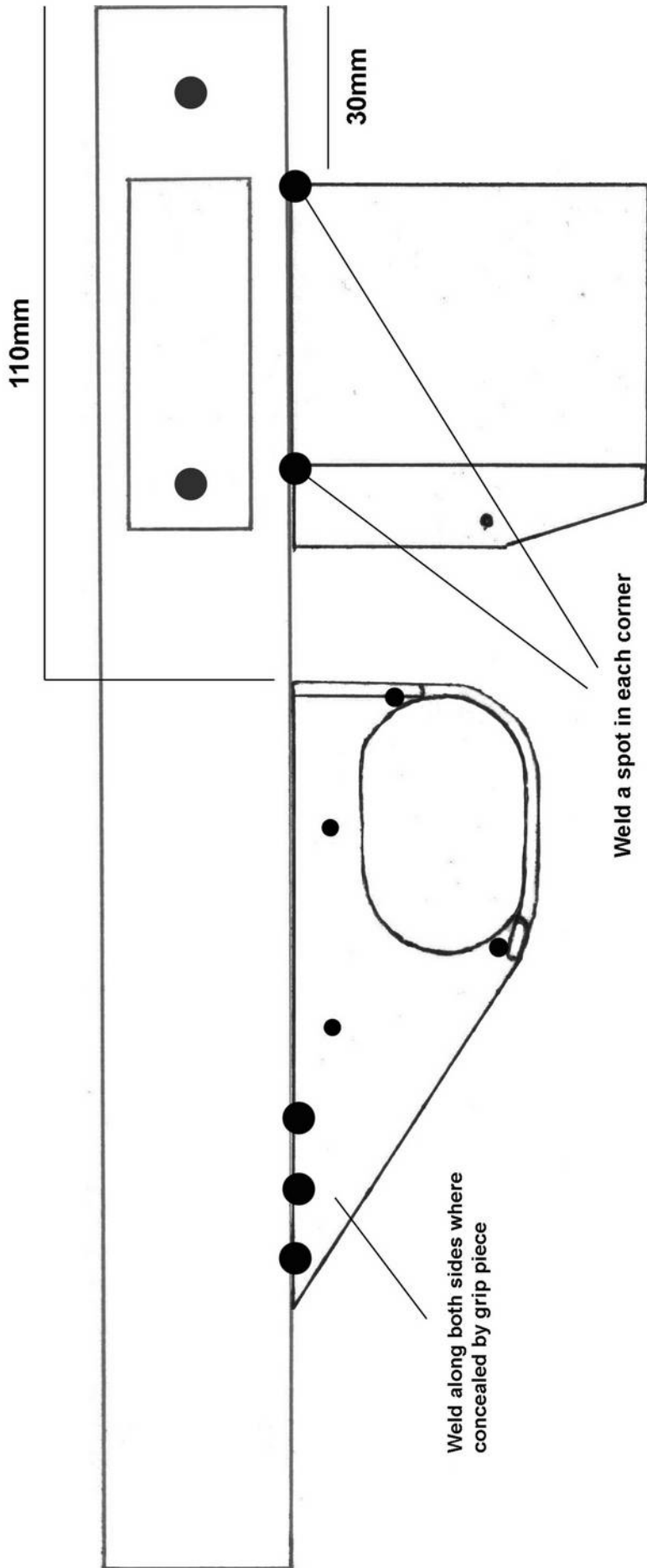

2 inches

Grip

Carve from a single piece of 1 1/2" thick plastic or hardwood. Round off all edges.

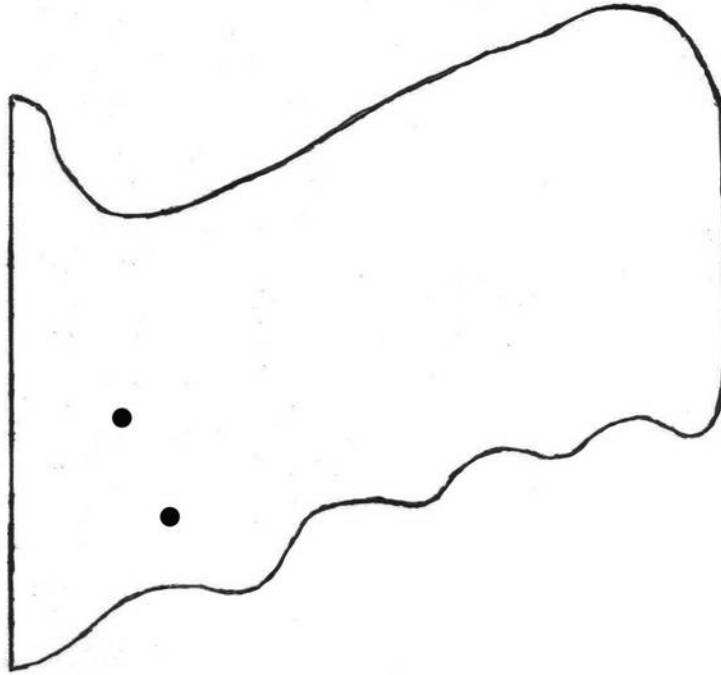

Use a combination of a handsaw and chisel to cut an 11mm wide slot into grip to match profile of trigger housing. Add a hole at point marked to seat sear spring securely. Attach grip using two m4 bolts passed through housing and threaded into one side of grip. Top should be flush against receiver allowing no movement. Reduce any wobble by applying wood putty or epoxy.

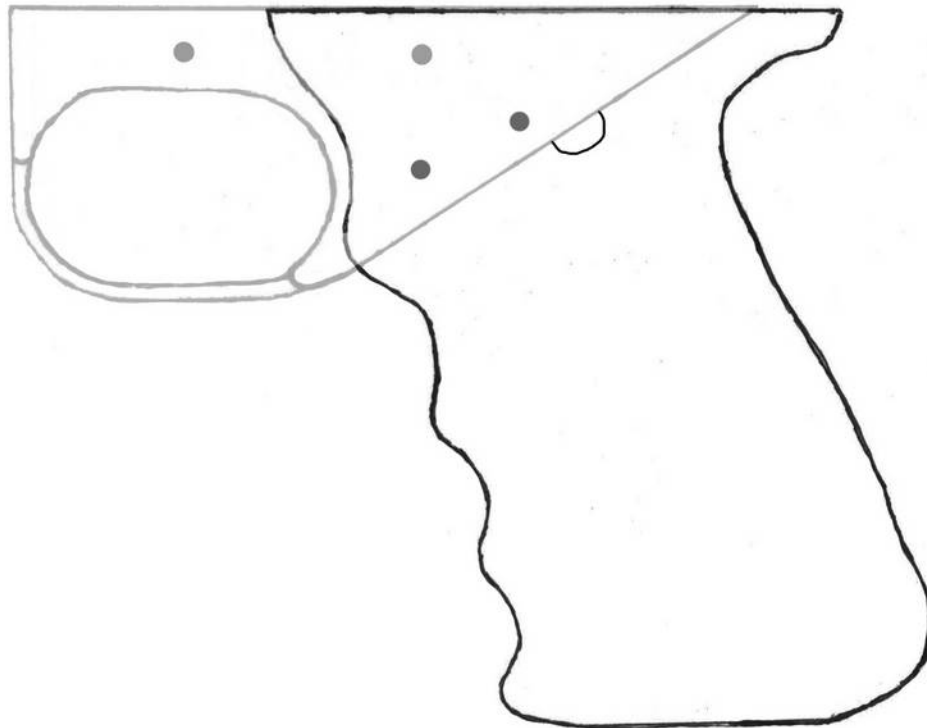

2 inches

Barrel assembly

Like the bolt, the barrel assembly is laminated from a length of 25mm x 2mm box tube sleeved with a length of 20mm x 2mm box tube. A 4mm deep cut is made leaving a protrusion for the feed ramp formed from both lower walls.

Front:

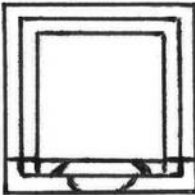

Use a dremel fitted with a grinding bit to form a bevel in feed ramp lip.

Side:

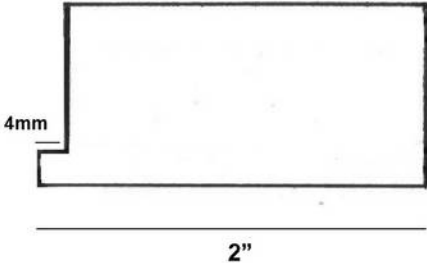

Use a 16mm+ drill bit to create cone at mouth extending inwards from very edges. Sand smooth.

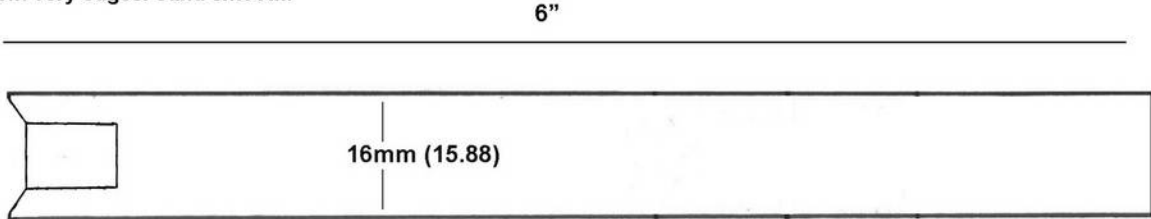

Two 4mm x 25mm sellock pins can be used to retain barrel in collar. Alternatively weld in place.

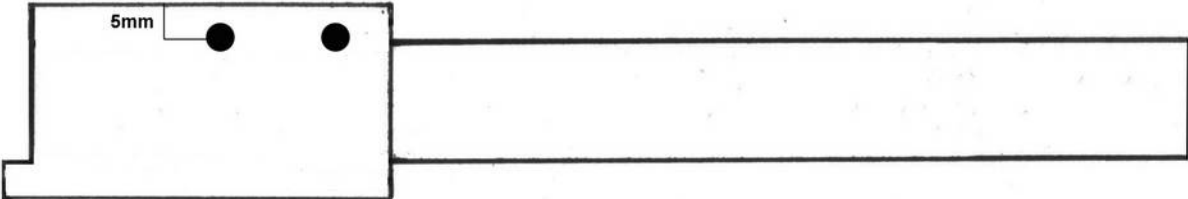

For legal purposes destroy dummy barrel and weld in place

2 inches

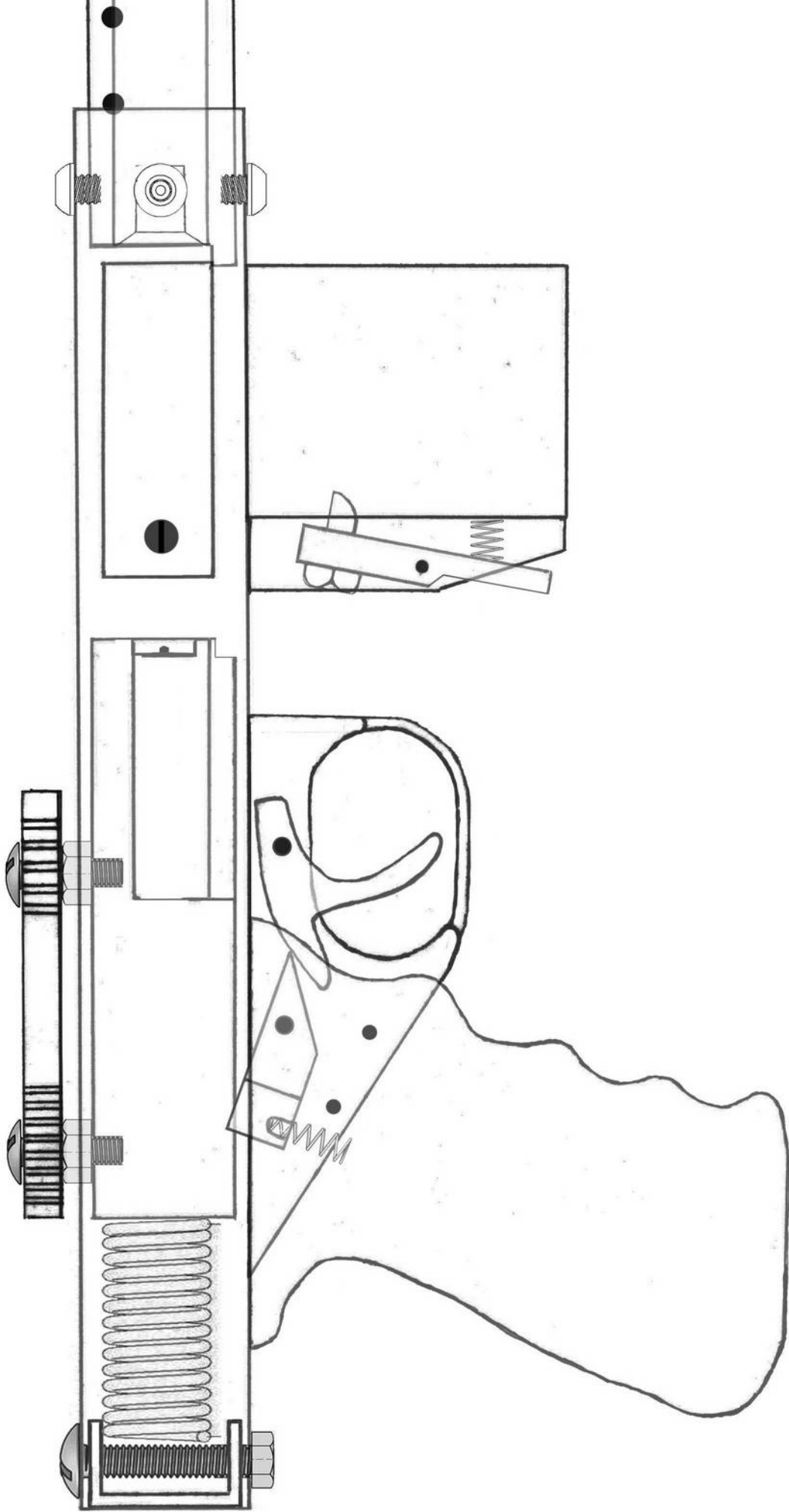

2 inches

Print on 8.5x11 US letter paper

Additional firepower:

