

A .50-caliber rifle is mounted on a tripod and positioned on a grassy field. The rifle is dark in color and features a large scope mounted on top. The barrel is long and has a textured grip at the muzzle. The tripod has three legs that are spread out on the grass. The background is a lush green lawn.

**THE .50-CALIBER  
RIFLE CONSTRUCTION  
MANUAL**

**WITH EASY-TO-FOLLOW FULL-SCALE DRAWINGS**

**Bill Holmes**

**THE .50-CALIBER  
RIFLE CONSTRUCTION  
MANUAL**





**THE .50-CALIBER  
RIFLE CONSTRUCTION  
MANUAL**

**WITH EASY-TO-FOLLOW FULL-SCALE DRAWINGS**

**Bill Holmes**

PALADIN PRESS • BOULDER, COLORADO

*The .50-Caliber Rifle Construction Manual*  
*With Easy-to-Follow Full-Scale Drawings*  
by Bill Holmes

Copyright © 2002 by Bill Holmes

ISBN 1-58160-346-0  
Printed in the United States of America

Published by Paladin Press, a division of  
Paladin Enterprises  
Gunbarrel Tech Center  
7077 Winchester Circle  
Boulder, Colorado 80301 USA  
+1.303.443.7250

Direct inquiries and/or orders to the above address.

PALADIN, PALADIN PRESS, and the “horse head” design  
are trademarks belonging to Paladin Enterprises and  
registered in United States Patent and Trademark Office.

All rights reserved. Except for use in a review, no  
portion of this book may be reproduced in any form  
without the express written permission of the publisher.

Neither the author nor the publisher assumes  
any responsibility for the use or misuse of  
information contained in this book.

Visit our Web site at [www.paladin-press.com](http://www.paladin-press.com)

# WARNING

Although at the time this book was published it was perfectly legal for an individual to manufacture a firearm for personal use, experimental purposes, or research and development, it is possible that new laws have been enacted since then. It is the reader's responsibility to carefully research all pertinent laws before any firearm construction is attempted.

Technical data presented here on the construction, use, adjustment, and alteration of firearms inevitably reflect the author's beliefs and experiences with particular firearms, equipment, and components under specific circumstances that the reader cannot duplicate exactly. The information in this book should therefore be used for guidance only and approached with great caution. Neither the author, publisher, nor any distributor assumes any responsibility for the use or misuse of information contained in this book. *This book is presented for academic study only.*

# TABLE OF CONTENTS

Introduction	1
Receiver	3
Barrel	7
Barrel Accessories	13
Bolt	17
Trigger Assembly	29
Butt Stock	41
Scope Mount	43
Bipod	43
Muzzle Brake	47
Assembly and Firing	61

# INTRODUCTION

Some time ago when Paladin and I made *The Home Workshop .50-Caliber Sniper Rifle* video, we opened a can of worms that neither of us had anticipated. This video was never intended as a construction guide whereby one could simply look at it and build a gun; rather it was simply to show methods used to fabricate the component parts. It never occurred to me that anyone would actually expect to build such a gun simply from a video.

However, shortly after the video was released both Paladin and I were deluged with requests, even demands, for a set of drawings and dimensions to allow the building of such a gun. I began the project, but since I am now 72 years old, almost blind, and afflicted with Parkinson's disease, my work went rather slowly. But here it is, finally, and I apologize for any distress or problems the delay may have caused anyone.

Many people seem to feel that the .50 is an awesome small cannon that is dangerous to shoot and only good for criminal operation. In truth, this gun, just like any other, is no more dangerous than the person shooting it, and if any serious crimes have been committed with one, the news has been kept awfully quiet. I have never heard of an incidence. Actually, the only thing more dangerous about a .50-caliber than any other

rifle is its greater range. As long as a suitable backstop is used and the shooter knows where the bullet is going, even this complaint is nullified.

As of this writing it is legal to build such a gun for one's own use, provided the maker's name and address and a serial number are stamped on the receiver. Keep your eyes and ears open on this though. There has already been at least one bill introduced in the U.S. Congress trying to make .50-caliber rifles illegal. This bill didn't get anywhere, but rest assured there will be more attempts. Sooner or later the politicians will sneak a bill through to outlaw the .50-caliber rifle—and they probably won't even tell us about it until they come to seize the weapons. So stay alert.

Please remember that since we have no control over the materials or workmanship used in the project, neither Paladin nor I can accept any responsibility whatever regarding the safety or condition of a gun that someone else makes. However, if proper materials are used and heat-treated correctly, a decent chamber is cut, and the firing pin is set at the right protrusion, there is no reason why your gun should not be safe to shoot. Mine is.

It is recommended that you obtain a copy of *The Home Workshop .50-Caliber Sniper Rifle* video before you attempt to build



## THE .50-CALIBER RIFLE CONSTRUCTION MANUAL

one of these rifles. It may clarify some of the methods used that I failed to describe clearly.



The .50-caliber rifle is an effective and safe firearm with many uses.



# RECEIVER

The receiver body is made from a 36-inch length of 2 1/4-inch-diameter (2.250-inch) seamless 4130 tubing with a .120-inch wall thickness. It has an inside diameter of 2.010 inches, which gives .010 inch of clearance over a 2-inch-diameter bolt body. This allows the bolt to reciprocate freely, without binding.

Both ends of the tubing must be squared and perpendicular to the length. Unless a lathe with a hole through the headstock spindle that will accept this large-diameter tubing is available, you will likely have to use the milling machine to accomplish this. You must square the ends because unsquare ends will cause the rifle to fire groups erratically.

Most measurements shown in the drawings were made using the forward end as the starting point. A line should be marked along the exact top and bottom sides to measure from. On the guns I have built, I used six rows of oblong openings spaced equidistantly around the forward portion. These actually serve no good purpose except maybe to cool the barrel slightly, but they do improve its looks somewhat. These openings can be positioned however you wish or can be eliminated entirely with no ill effect.

The ejection port should now be cut to size, as well as the sear opening, and six rows of two each 1/4-inch (.250-inch) holes are drilled as indicated. The barrel-retaining sleeve, which secures and

supports the rear end of the barrel, is positioned and welded in place through these holes by what is known as rosette welding. This part, however, should not be welded in place until the barrel, bolt, and barrel extension are completed.

Now comes the fun part: cutting the bolt slot. If two vises are available, both should be used, one near each end of the cut. A fairly close-fitting piece of round stock should be placed inside to prevent the tube from collapsing when the slot is cut, and the cut should be stopped just before it cuts through at the rear. This tubing has a tendency to spring open when cut all the way to the end. It should have the two screws in place through the buttstock extension before the entire cut is made.

The narrow section between the back end of the loading/ejection port and the bolt slot should be included just to keep the receiver tube from spreading open slightly at this point.

The trigger and sear base are now welded, or silver-soldered, in place, and this part is laid aside until the rest of the receiver components are fabricated (along with the barrel and bolt) and fitted and assembled.

Note that the receiver drawing (enclosed as a separate foldout) shows the receiver at full size.

THE .50-CALIBER RIFLE CONSTRUCTION MANUAL

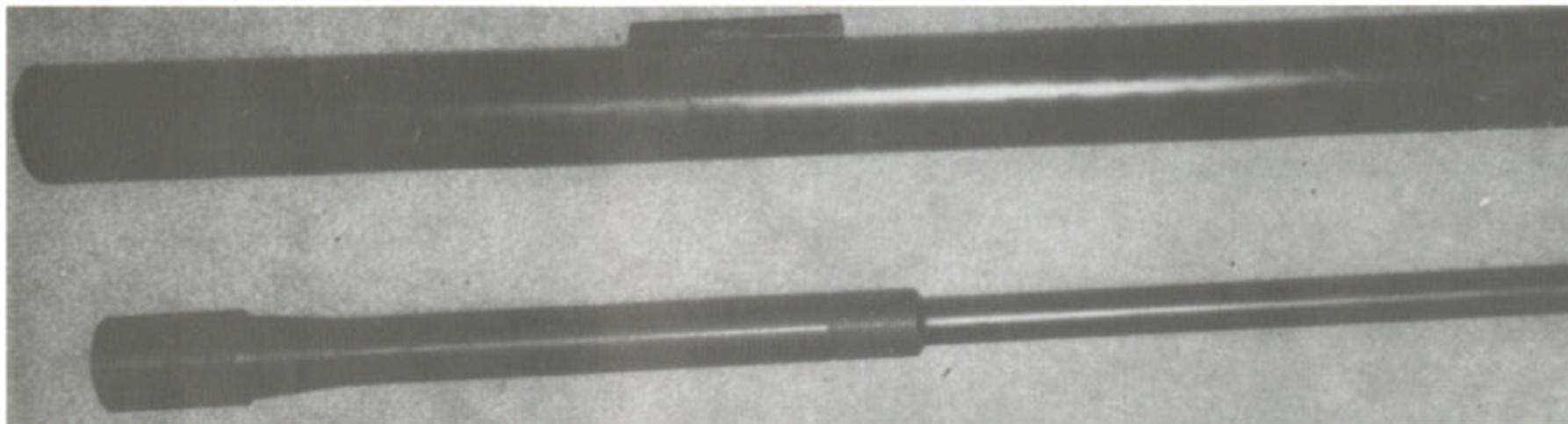

Barrel and receiver.

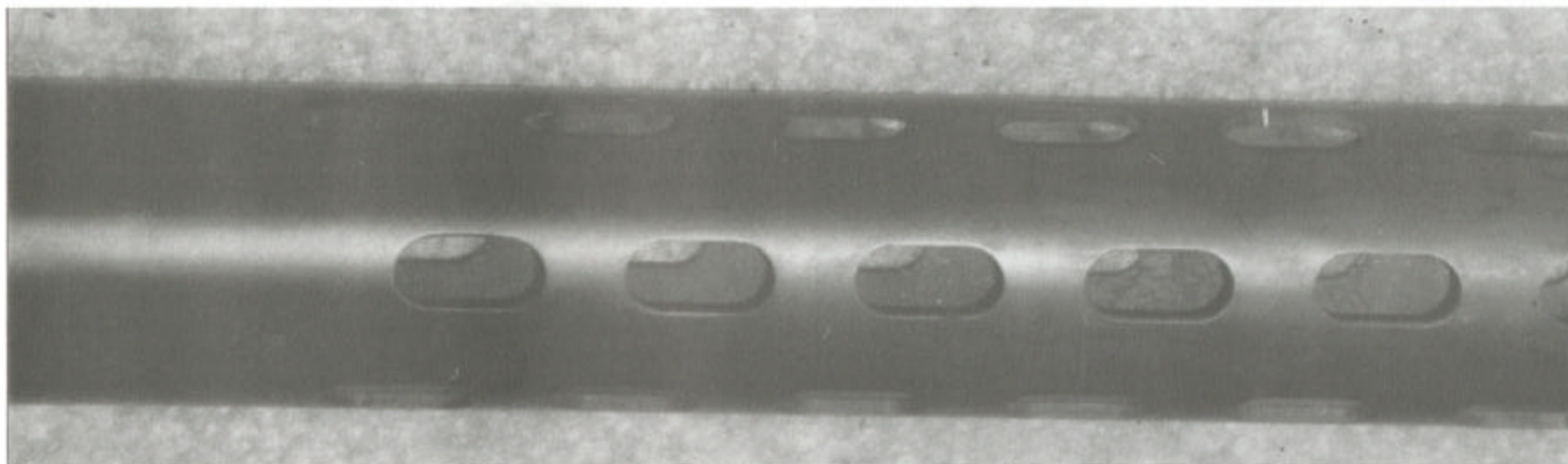

Front end of receiver.

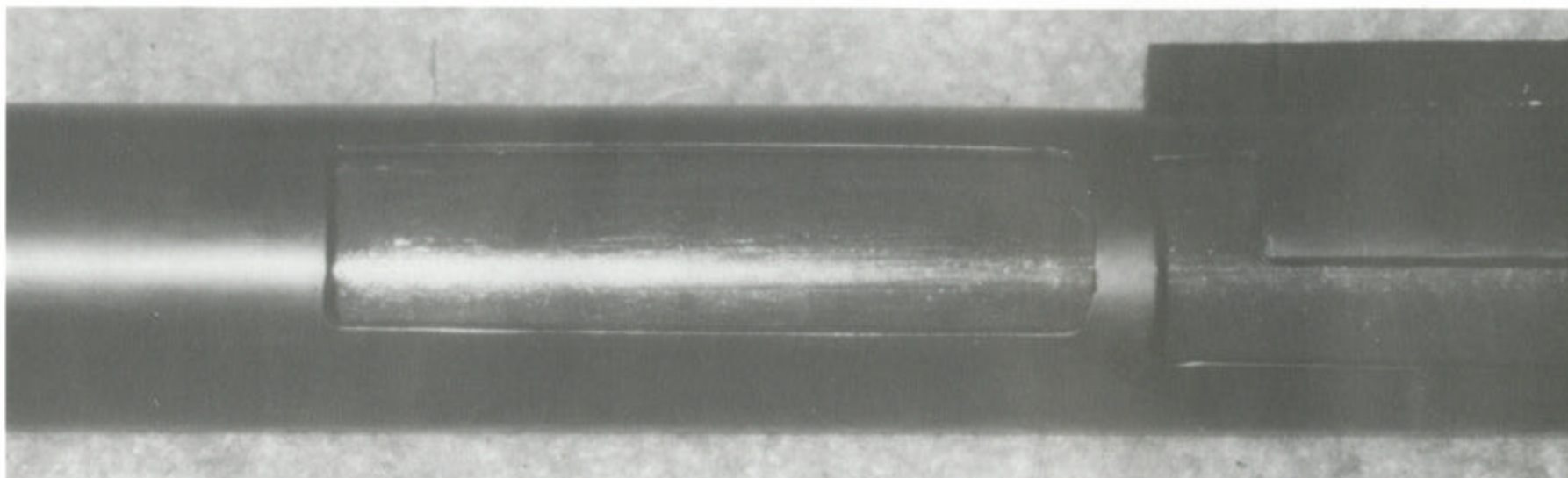

Receiver, showing ejection port.

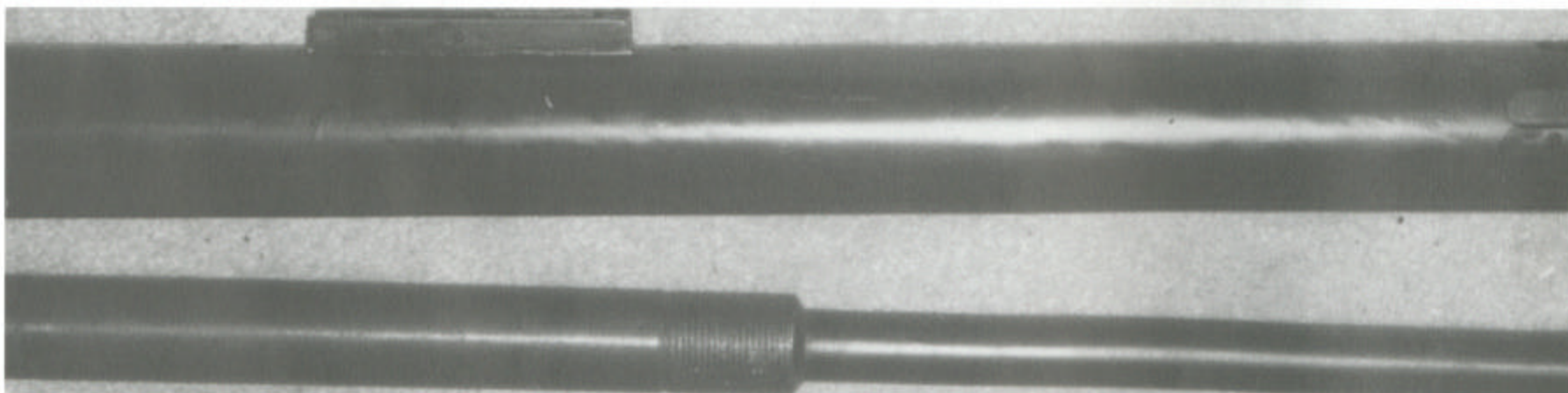

Trigger mounting bracket and middle threaded section for barrel-retaining nut.



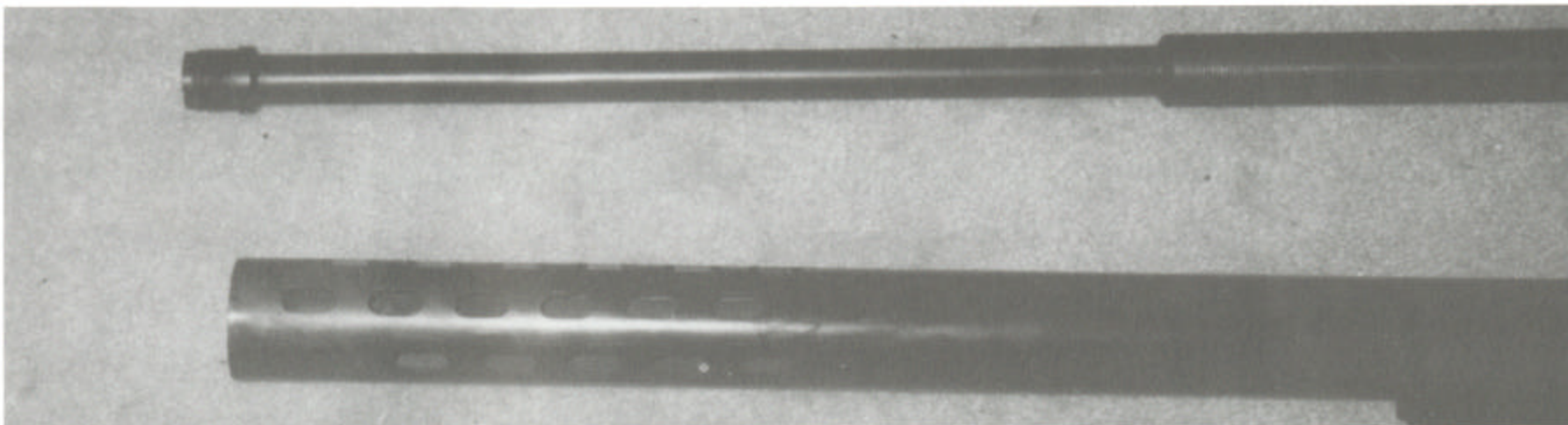

Barrel threads for retaining nut and muzzle brake.

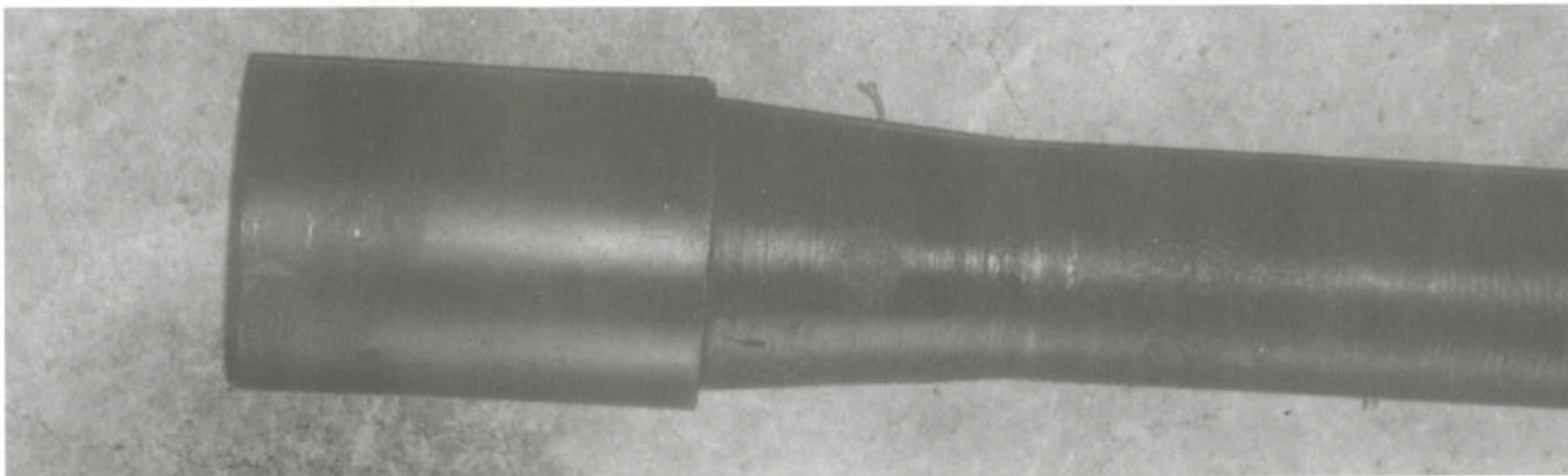

Breech end of barrel with locking lug section in place.



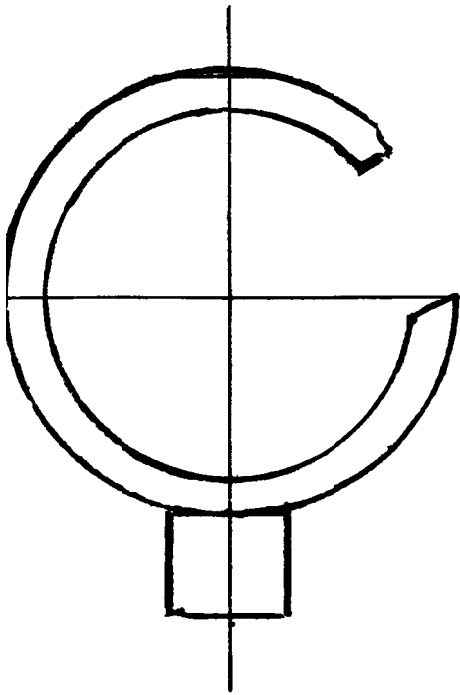

2.250"

REAR VIEW

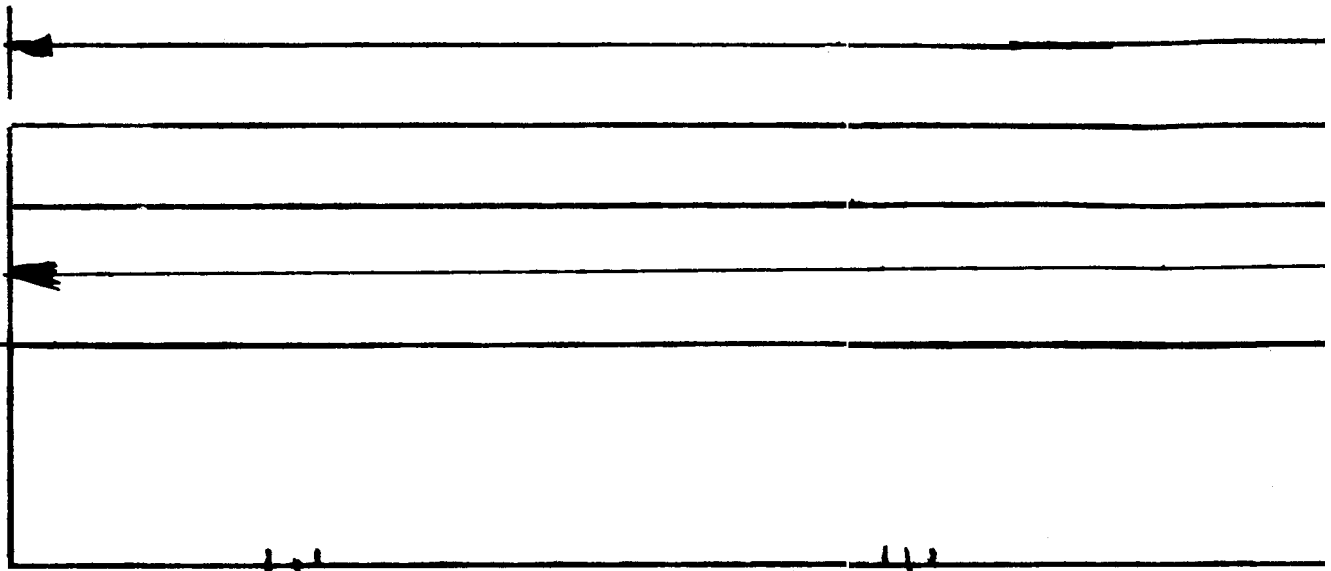

RIGHT SIDE

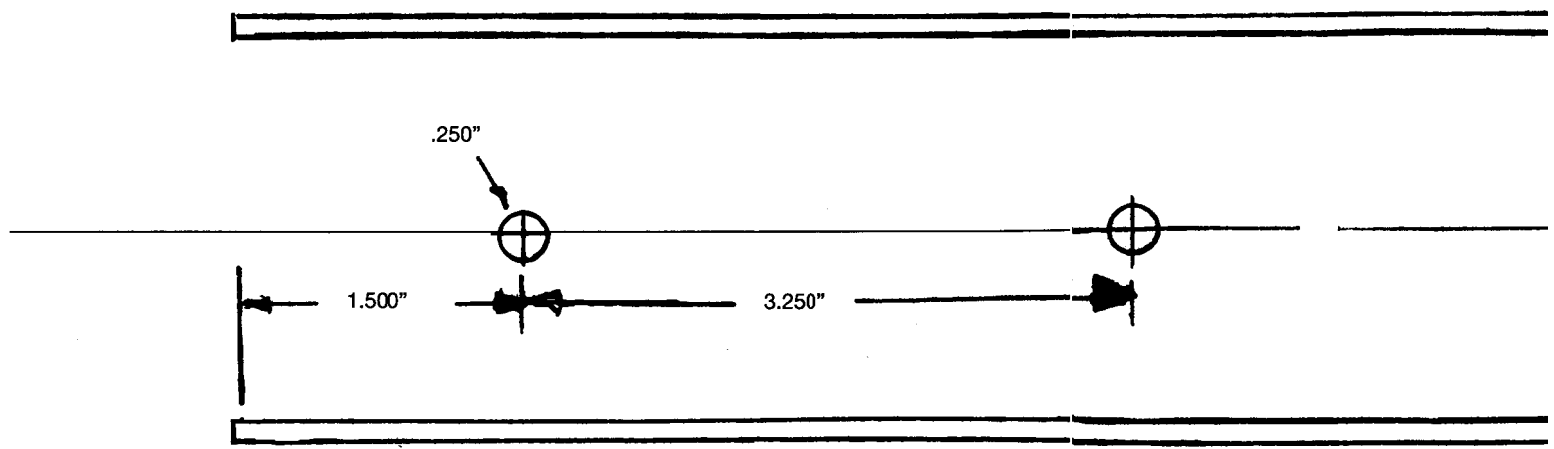

.250"

1.500"

3.250"

RECEIVER BOTTOM



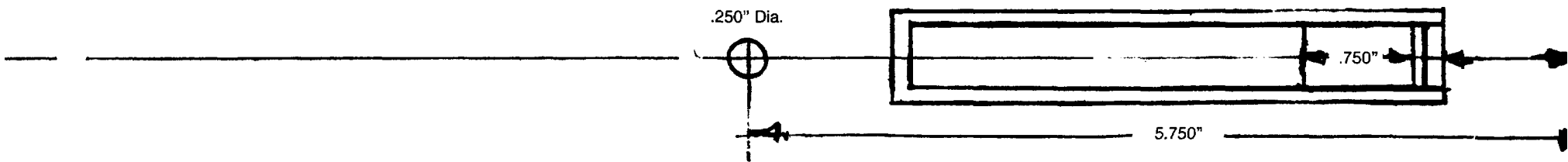
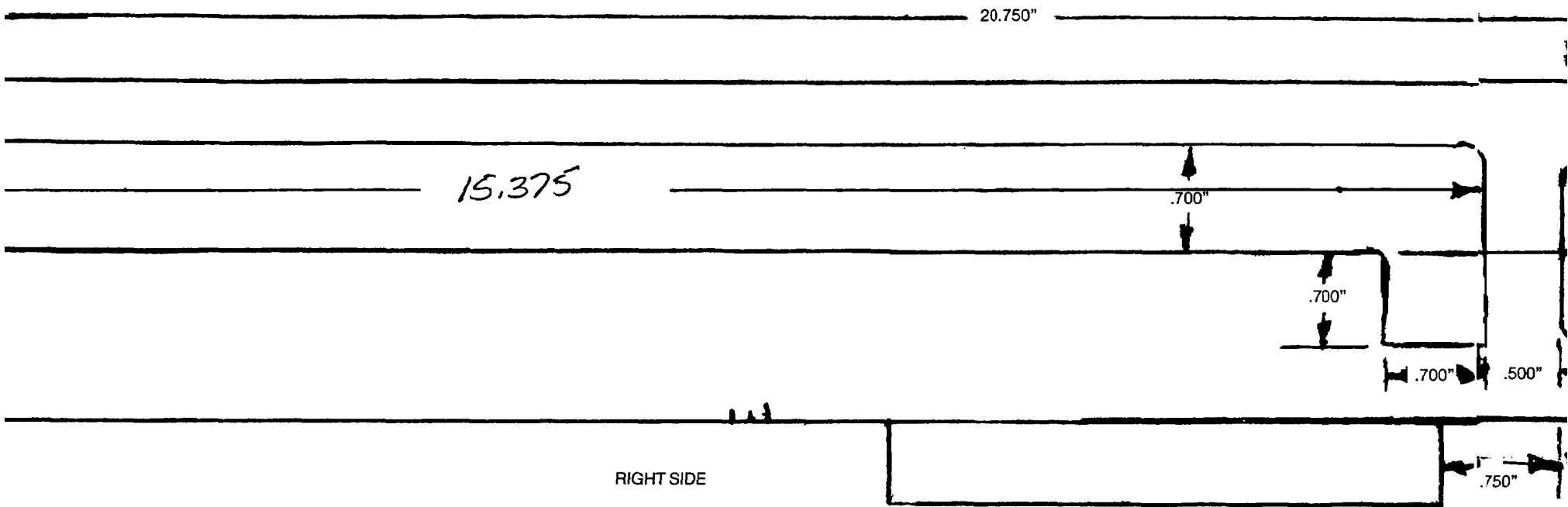

RECEIVER BOTTOM

SCAL

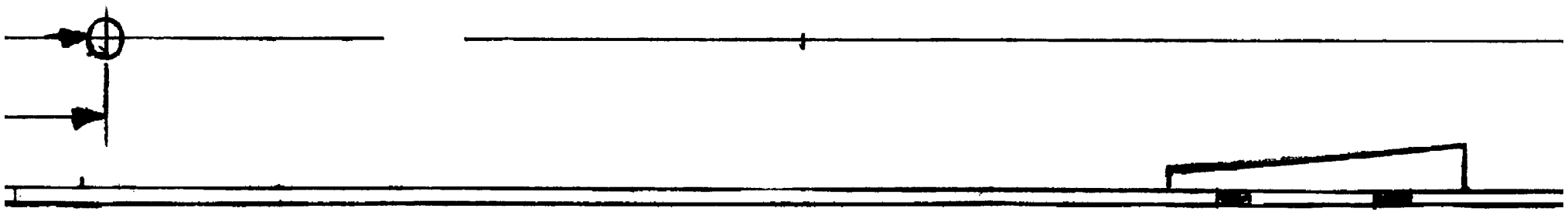
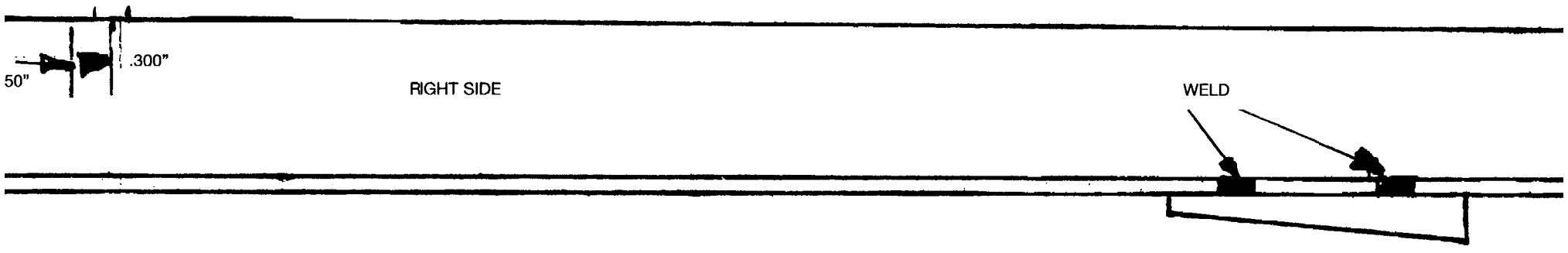
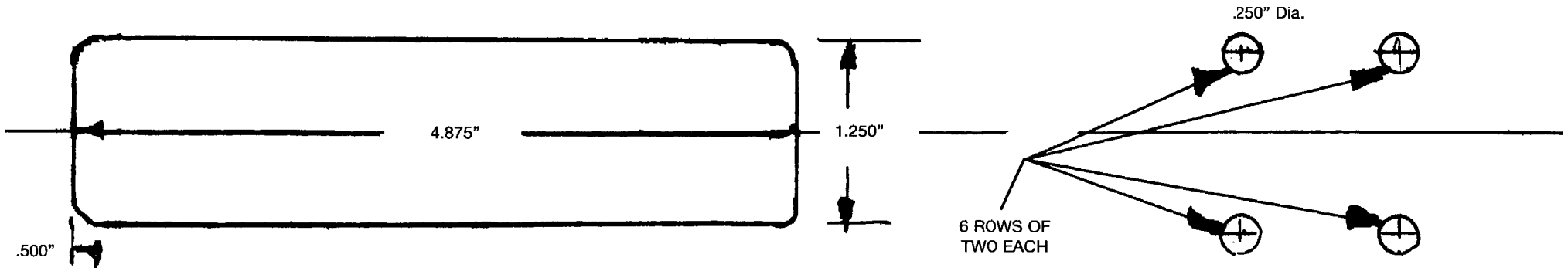
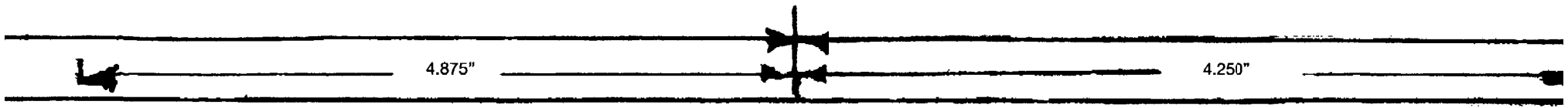

SCALE: 1/1

RECEIVER BOTTOM

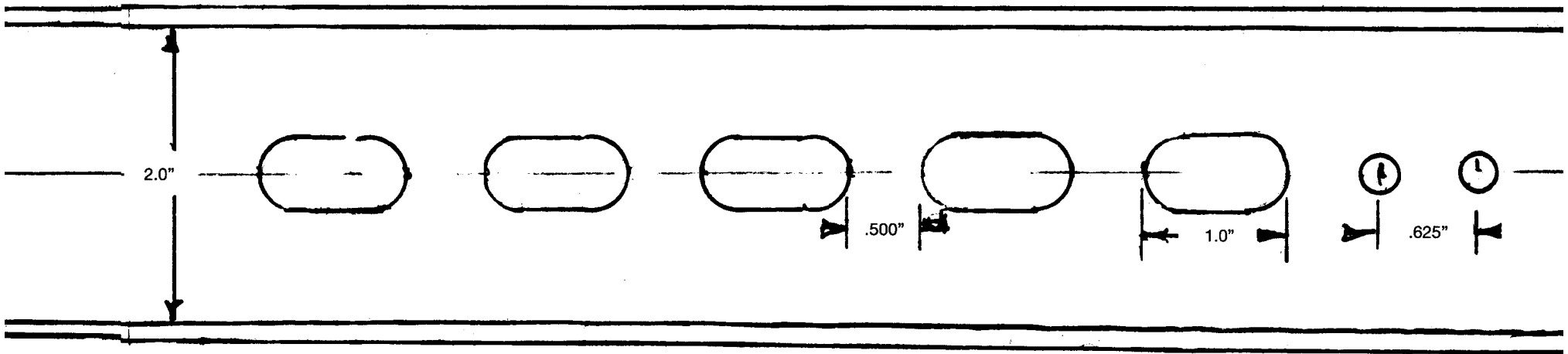
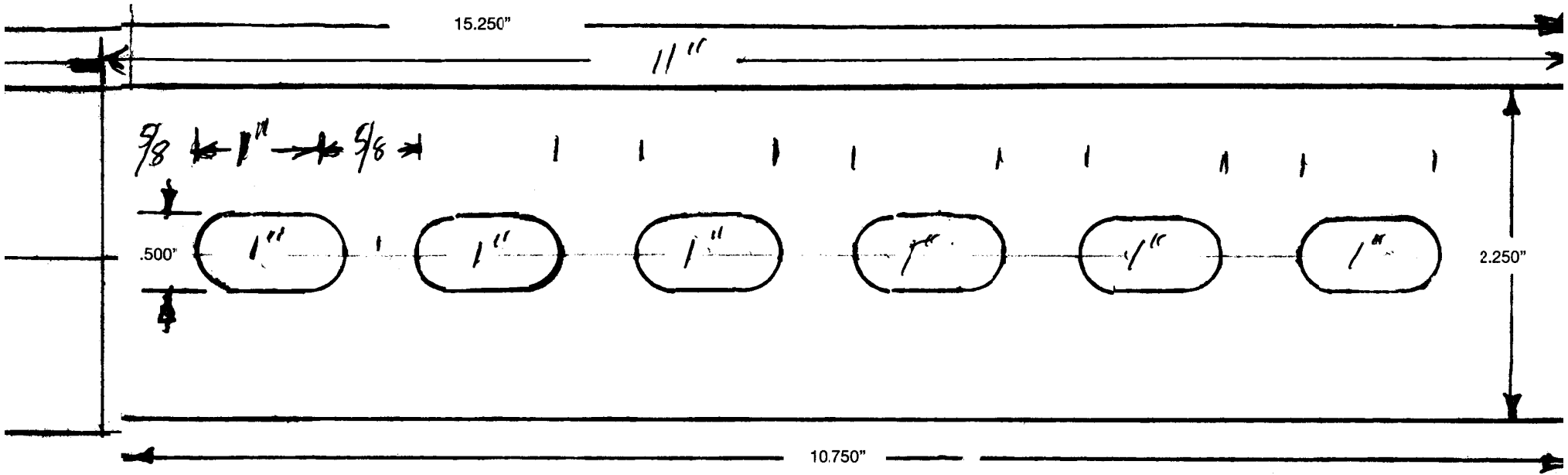



# BARREL

The barrel can be turned from a commercial blank or made from a surplus military barrel. M2 barrels are presently available from Oyster Bay Industries (31 South Street, Oyster Bay, NY 11771). These are new barrels, and their biggest drawback is that they have enough Cosmoline on each one to protect a tank. On the other hand, they contain enough surplus material to allow making up most of the other barrel parts.

Included in the barrel assembly are the barrel proper, barrel extension, barrel support sleeve, muzzle brake, and barrel-retaining nut.

The M2 barrel is sawed into sections large enough to make the designated parts. The barrel sections, as well as all other parts, are squared on the ends and turned to size. All threads are 12 threads per inch (TPI).

Both the barrel section, which contacts the barrel retainer, and the retainer are turned with a matching 4-degree taper. This causes a solid, in-line lock-up and support for the barrel at the breech end. The barrel extension must have three locking lugs (which mate with the bolt lugs) machined into it. This is best done with some sort of dividing head. But if none is available,

don't give up. Wrap a length of masking tape around the diameter of the part, measuring the length precisely. This is then divided into three parts and rewrapped, and their positions are marked on the barrel extension. These marks are then used as centerlines to cut the lugs with the milling machine. Some file work may be required in the shaping of these. If care is taken, a precise fit will result.

When smaller lathes are used for this, it will be necessary to turn the barrel one-half length at a time (assuming that a large enough hole to accept the smaller portion exists). If the end with the smaller diameter is pushed through the headstock, the larger end can be turned to size and threaded. Do not attempt to chamber the barrel until the barrel extension and bolt are made. The barrel is then reversed in the spindle and the smaller portion turned. The threads for the muzzle brake and barrel-retaining nut are cut at this time.

The military surplus barrels from Oyster Bay are heat-treated to a hardness that is slower and harder to machine than that of commercial barrels. However, the barrels are tougher and will usually wear better and last longer than their commercial counterparts.

THE .50-CALIBER RIFLE CONSTRUCTION MANUAL

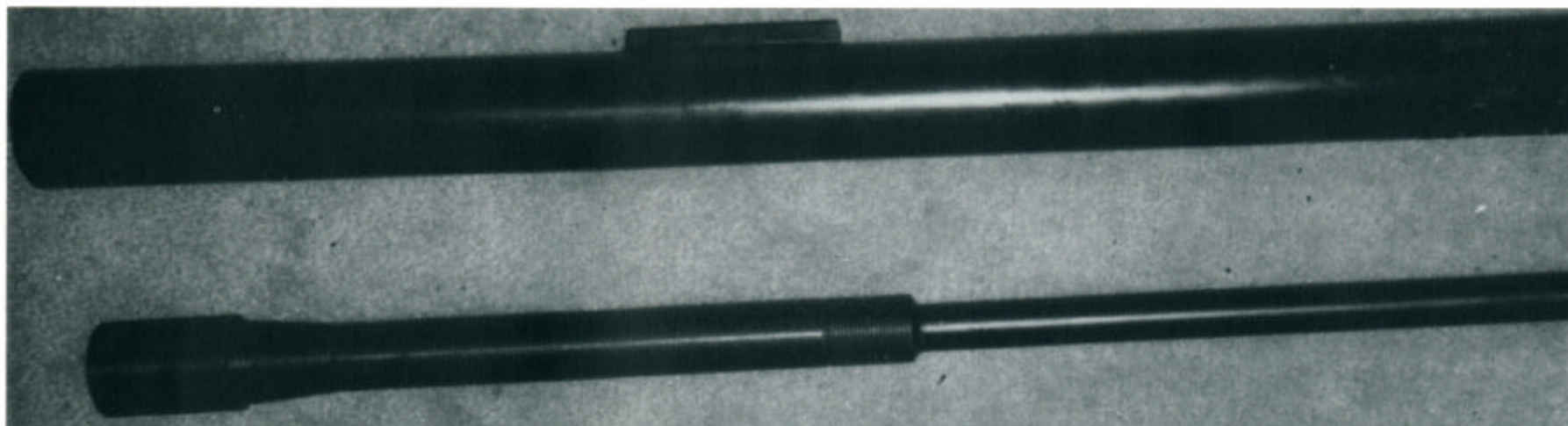

Barrel and receiver.



Muzzle end of barrel showing muzzle brake threads.

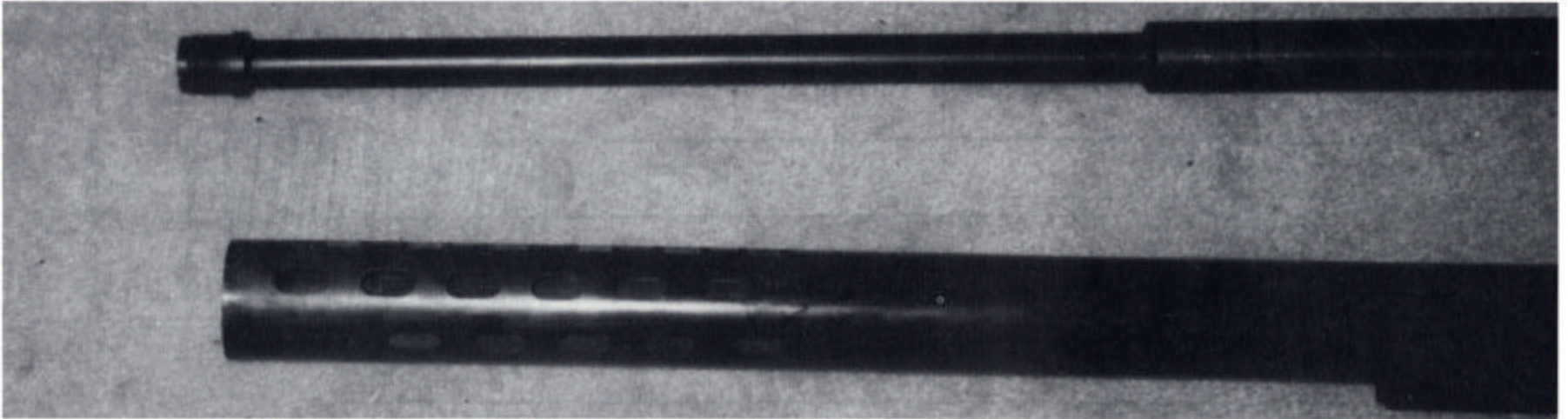

Barrel threads for retaining nut and muzzle brake.

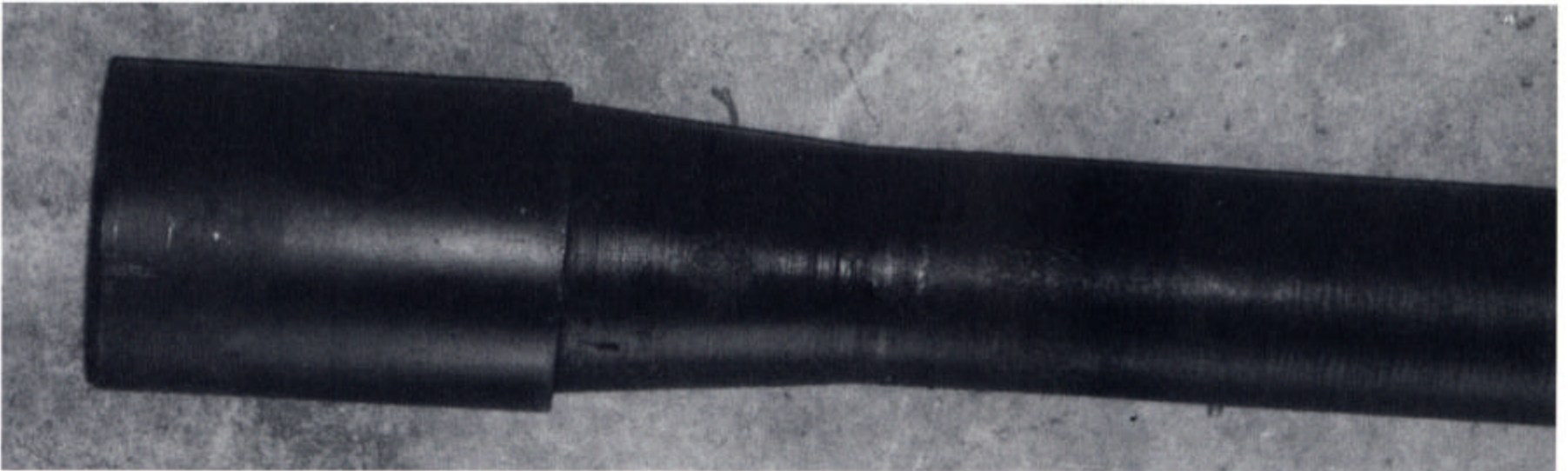

Breech end of barrel with locking lug section in place.

THE .50-CALIBER RIFLE CONSTRUCTION MANUAL

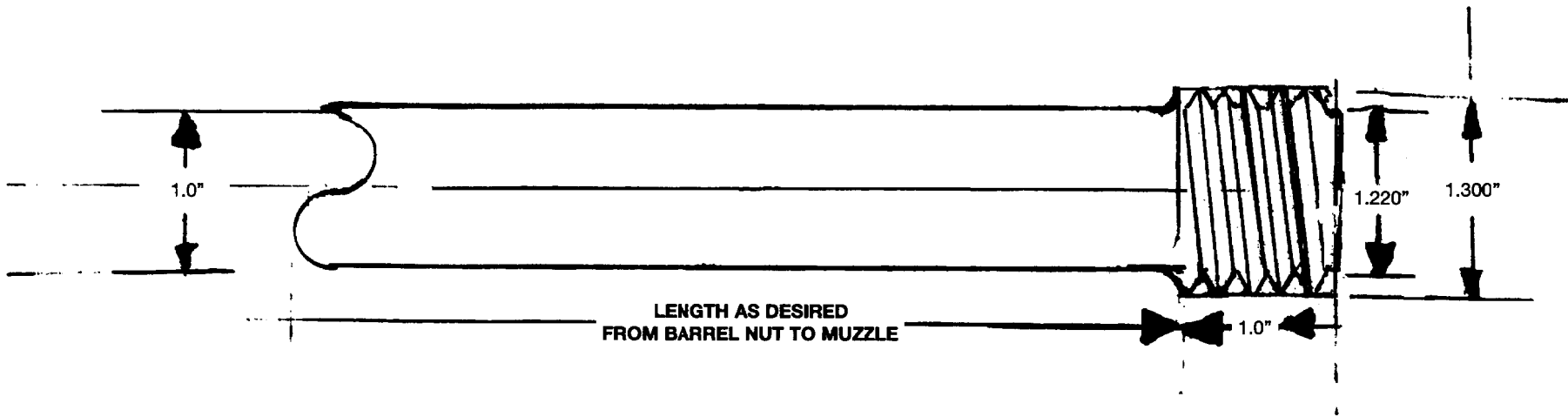

BARREL, FORWARD END

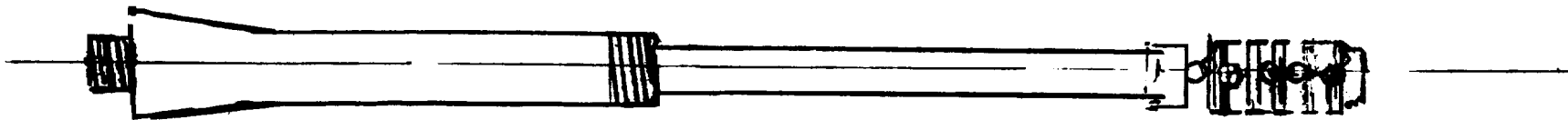



**BARREL**

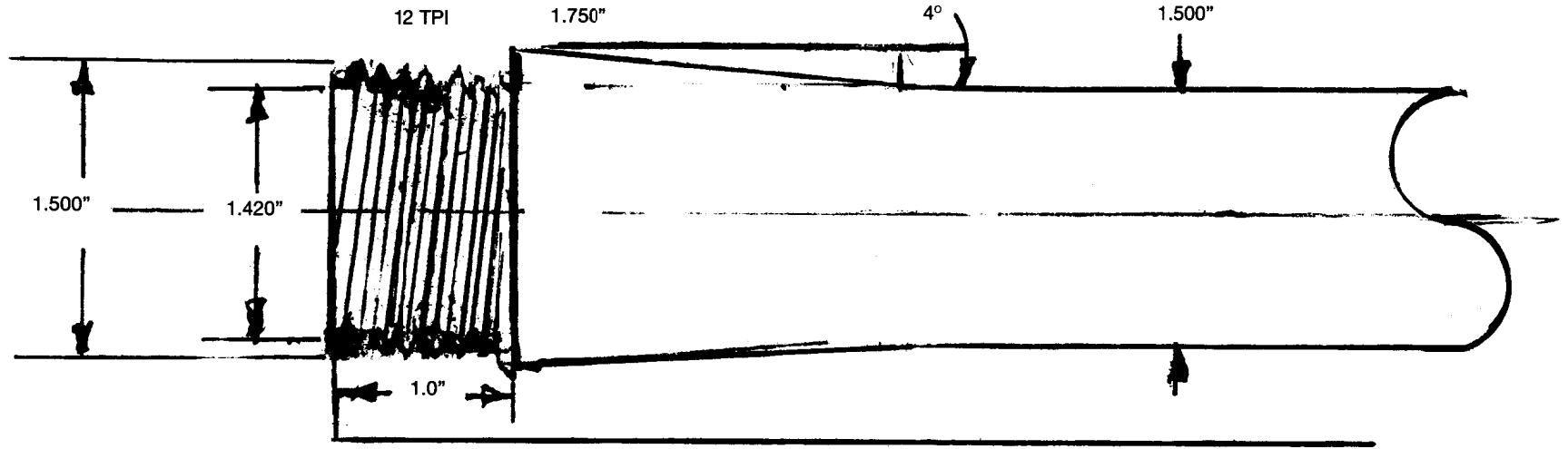

**BARREL, BREECH END**

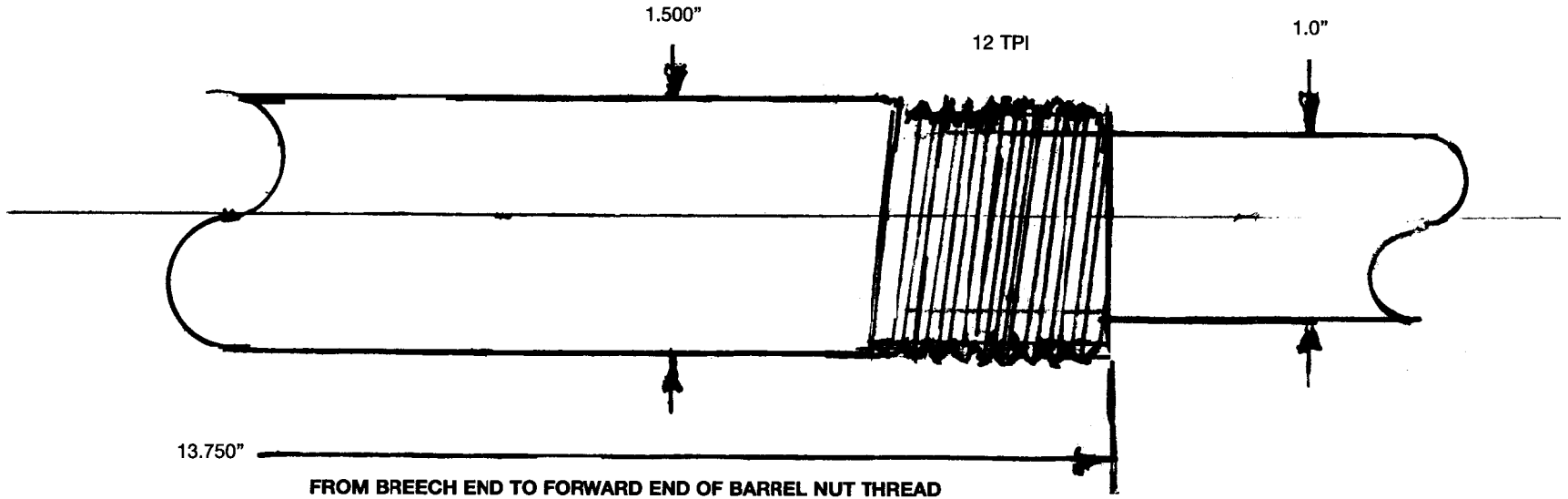

**FROM BREECH END TO FORWARD END OF BARREL NUT THREAD**

# BARREL ACCESSORIES

The barrel-retaining sleeve is made from 4140 or 4340 material. This should be a slip fit inside the receiver tube. The inside of this part (sleeve) should be closely fitted by tapering to the same dimensions as the barrel shank (I used 4 degrees) so that when pulled into place inside the receiver, and with the barrel nut tight and under a slight amount of tension, a solid installation results. In many cases this enhances accuracy.

The muzzle can now be crowned and the threads cut for the muzzle brake installation and the barrel nut. Both are cut 12 TPI.

The barrel extension, which contains the locking lugs that mate with the bolt lugs, is made from a close-fitting section of good-quality steel, preferably 4140 or 4340. A 1-inch hole is bored through the center of the part. The hole is then enlarged to 1 1/2 inches (1.500 inches) inside diameter by 1 3/4 inches (1.750 inches) in depth. The shoulder remaining at the bottom of this enlargement should be smooth and square since the bolt lugs lock against

this. The front end is now threaded to fit on the barrel tenon. This is 12 TPI pitch by 1 1/2 inches diameter by 1 1/4 inches (1.250 inches) deep. This thread joint should fit snugly, with some effort required to screw it home.

The barrel should once again be placed in the lathe and the chamber cut. I recommend that a roughing reamer be used first, followed by the finish reamer. Accurate headspace gauges should also be obtained and used because there is sometimes quite a bit of difference between cartridges obtained from different sources. Clymer Manufacturing Company is an excellent source for these gauges.

It should be emphasized here that ammunition obtained from different sources would not even fit into a standard chamber. U.S. military and Israeli ammunitions are fairly consistent, but those from some other countries may not even allow the bolt to close. Ammunition must be made to fit a standard chamber, not vice versa.

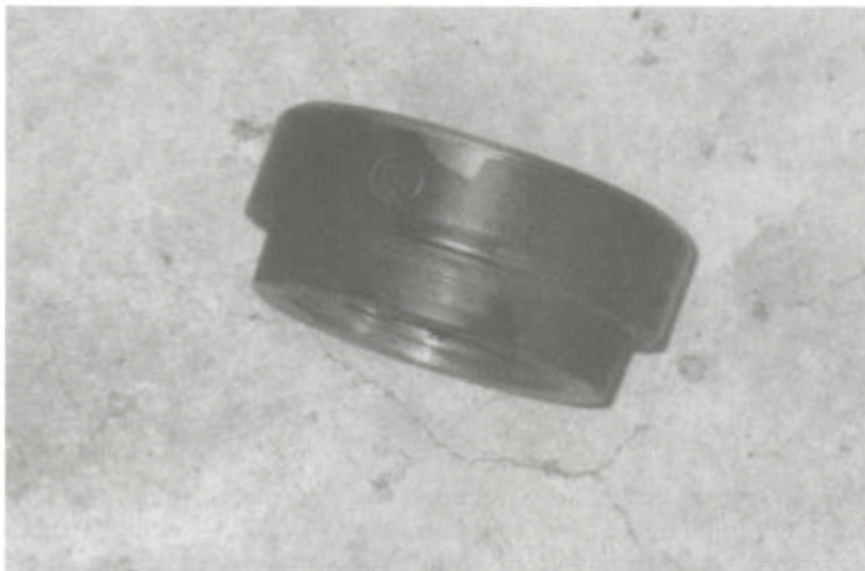

Barrel nut (top view).

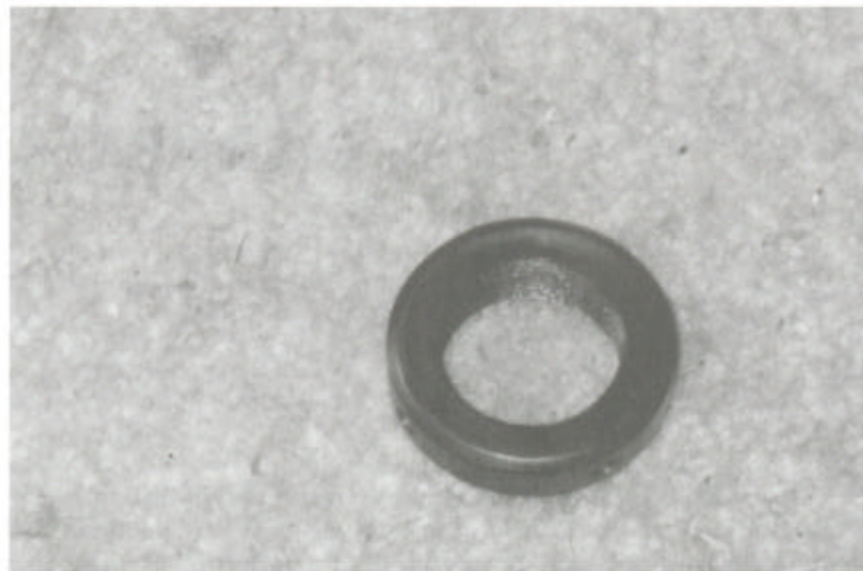

Barrel nut (front view).

**BARREL ACCESSORIES**

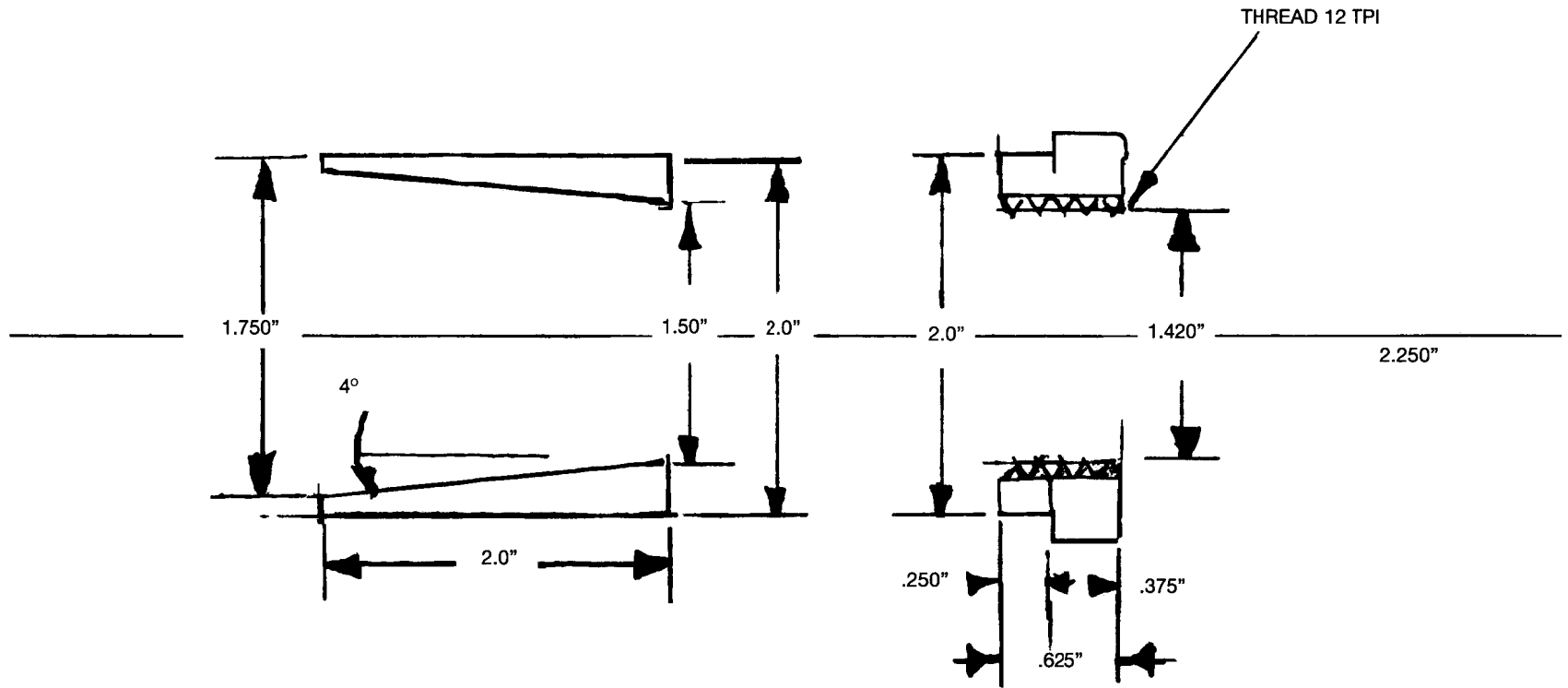

**BARREL BUSHING**

**BARREL NUT**

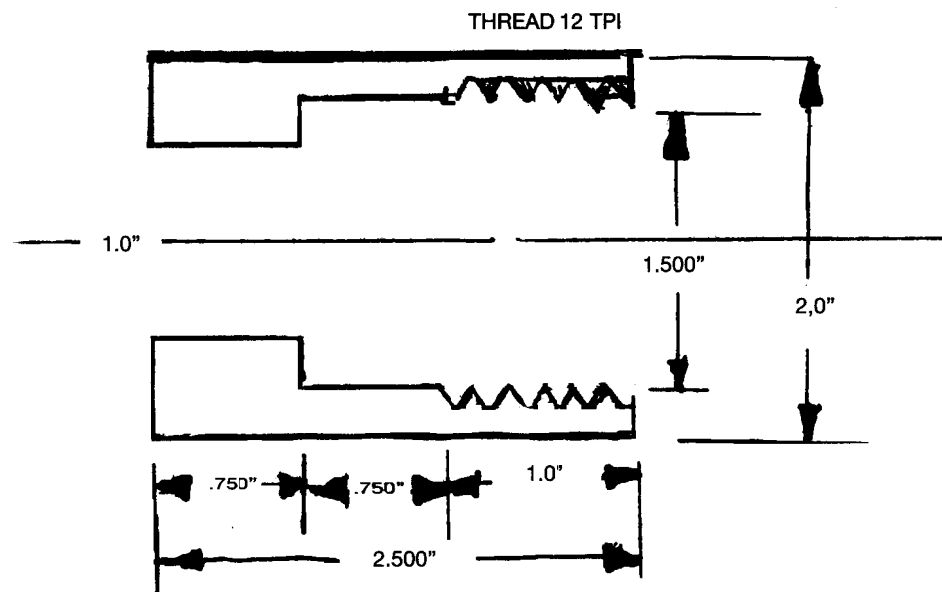
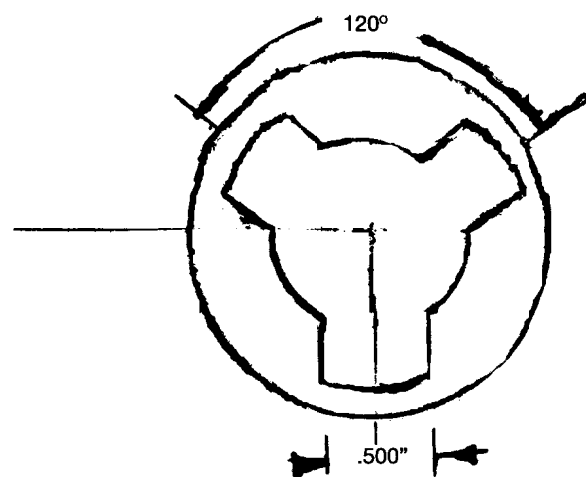

**BARREL EXTENSION**



# BOLT

The bolt, constructed from the same material as the barrel extension (4130, 4350), is only slightly more difficult than those built for smaller actions. It's just larger and takes longer. However, several drill extensions must be made up to drill the firing-pin hole through the bolt.

With the ends of the blank squared, a small hole is started through one end using a #2 center drill. This is then enlarged and lengthened with a 3/32-inch (.087-inch) drill. This will provide the opening in the bolt face for the smaller end of the firing pin. Drill this to a depth of 3/4 inch or so. The drill used here, as well as all the others used in this bolt construction, should be new and sharp. When in use, they should be withdrawn frequently and cleaned and relubricated. A counterbore, two hundred thousandths of an inch deep and to a diameter that will just accept a case head, is machined in the bolt face. The bolt face so formed must be very smooth.

While chucked in this position, the bolt body should be turned to a diameter of 1 1/2 inches (1.50 inches), as shown in the drawing, and the groove should be cut to form the flange that forms the locking lugs. The rear side of this groove should be very smooth and square with the bolt body. The rest of the bolt body could be kept at a constant 2-inch diameter. But turning it as shown and

adding the outer sleeve establish clearance for the sear and loading ramp, as well as reducing friction considerably.

At this point, the bolt is reversed in the chuck (preferably a four-jaw one) and centered using a dial indicator. You can now proceed to drill and bore the inside to the dimensions shown. You will need to add extensions to some of the drills. Drill the holes as deep as possible, using new, sharp drills before using the extended ones. With luck and all possible care, this hole will meet and center on the small hole started from the other end.

A slot must be milled, as shown, to provide clearance for the sear, and the locking lugs must be machined to mate with the lugs in the barrel extension.

With the barrel in place and the bolt in a forward position, ready to close but unlocked, the bolt handle position is scribed through the opening in the receiver slot. The bolt is removed from the receiver, and the handle is welded in place. This should be made up slightly oversized and fitted by removing material to the point that the bolt works freely. That is, it opens and closes and moves forward and back without effort.

The extractor should be machined and installed in the upper right-hand bolt lug. When the bolt is opened, this pulls the empty

## THE .50-CALIBER RIFLE CONSTRUCTION MANUAL

case to a point where a finger can be hooked over the mouth of the empty case and the case pulled free. No ejector is used in this design since, as a single shot, it is desirable to save the empty case for further use with as little deformation as possible.

The cocking cam is located and marked through the receiver slot and cut as shown. As in other instances, this should be fitted during construction and assembly and may not conform exactly to the dimensions shown.

The firing pin is turned from 1/2-inch (.50-inch) material. This is best done in three stages: (1) forming the front portion, (2) reversing the pin and turning the rear section to size, and (3) threading the rear section, with the front portion formed first.

The bushing, which holds the firing pin in place is made as shown. The cocking piece also is made from 2 1/4-inch-diameter material (2.250-inch-diameter) and, again, fitted as assembled.

A hole is drilled through both the bolt body and the firing pin bushing to hold the assembly in place. This should be done in one operation, with the parts assembled and in place. The entire assembly is now fitted and polished until smooth operation is achieved.

The three bolt-lug openings are laid out on the face of the bolt, an equal distance apart, using a dividing head or spacer of some sort. If neither of the latter is available, this spacing can be accomplished by wrapping a piece of masking tape around the diameter and marking the exact diameter on the tape, which is then removed and marked off in three parts. It is then again wrapped around the bolt, whereby each line becomes the centerline of each lug. The openings can now be cut, 1/2-inch wide and 1/4-inch deep, using a 1/4-inch end mill. The radiused corners can be made square, if desired, with the use of a small square file.

No attempt should be made to chamber the barrel until both the bolt and barrel extension are finished.

The barrel-retaining nut is a straightforward lathe job. It is threaded inside to match the barrel threads. The outside is turned to the same diameter as the receiver tube, and one end is turned to just fit inside the tube.

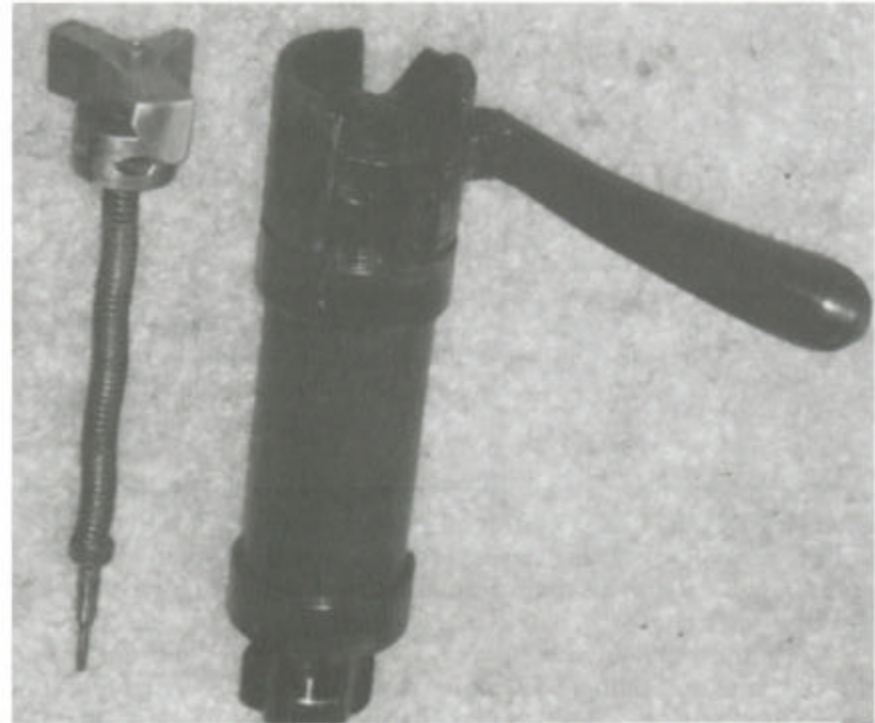

Bolt with firing mechanism removed.

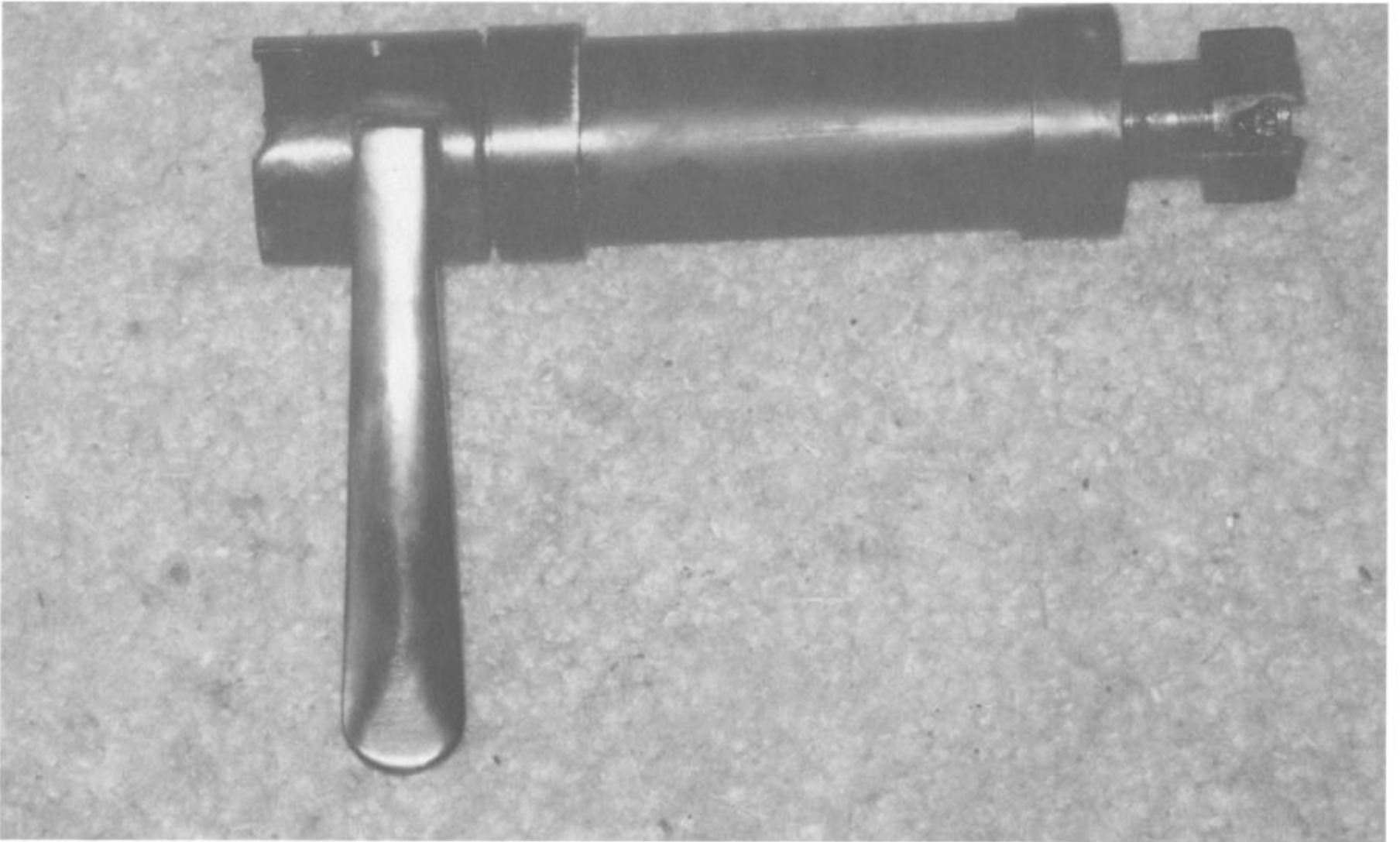

Bolt, right side.

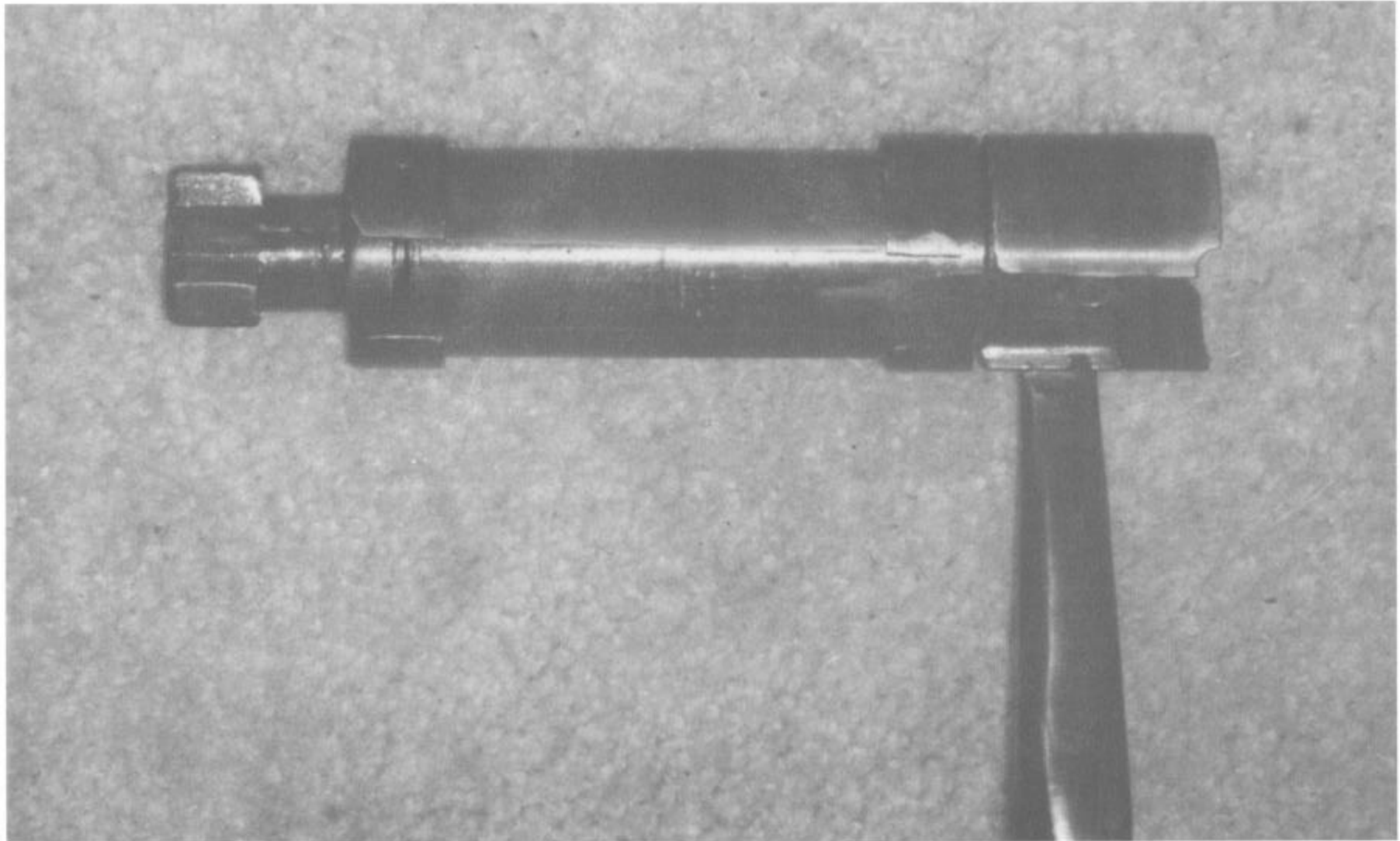

Bolt, bottom side.

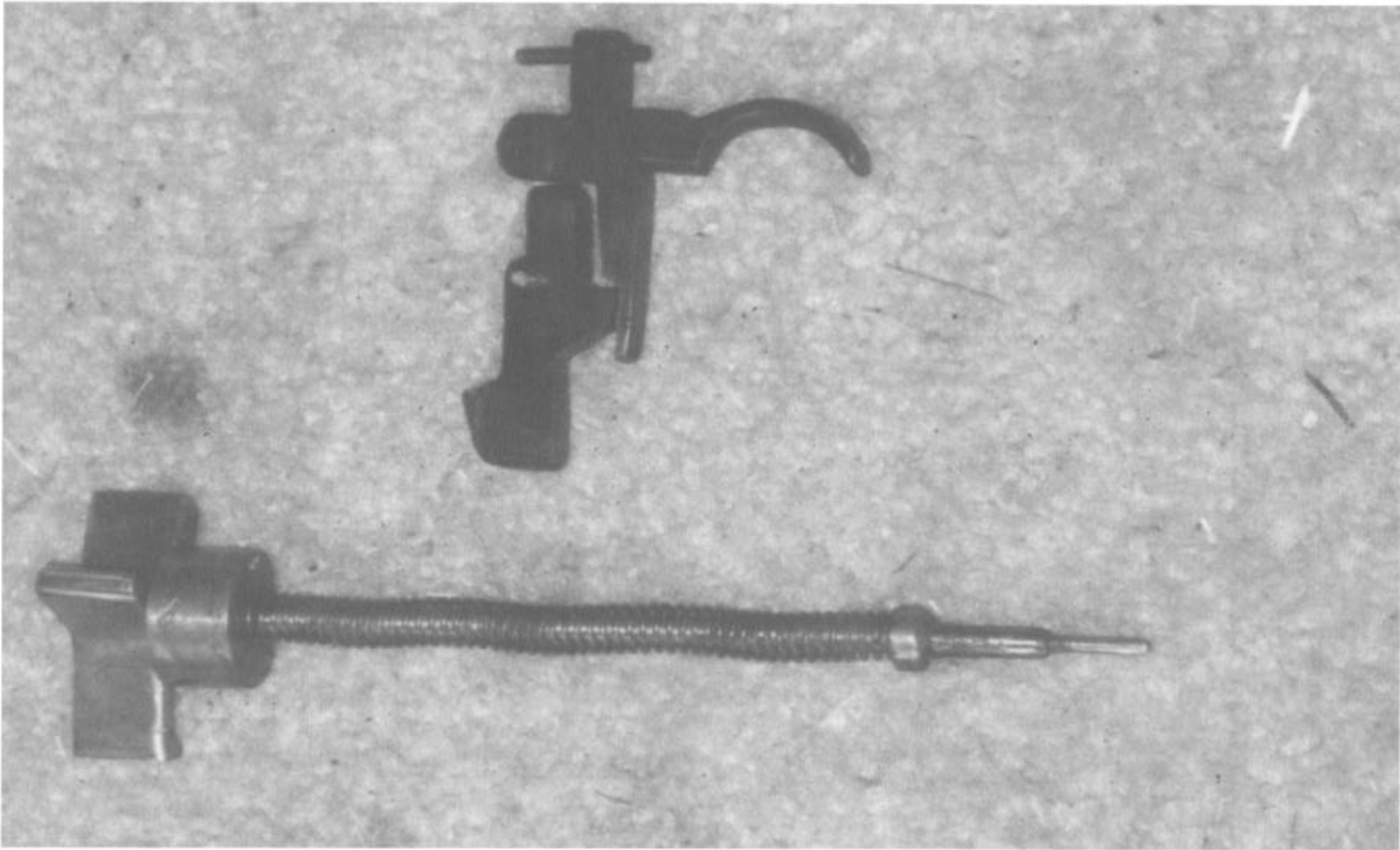

Firing mechanism.



THE .50-CALIBER RIFLE CONSTRUCTION MANUAL

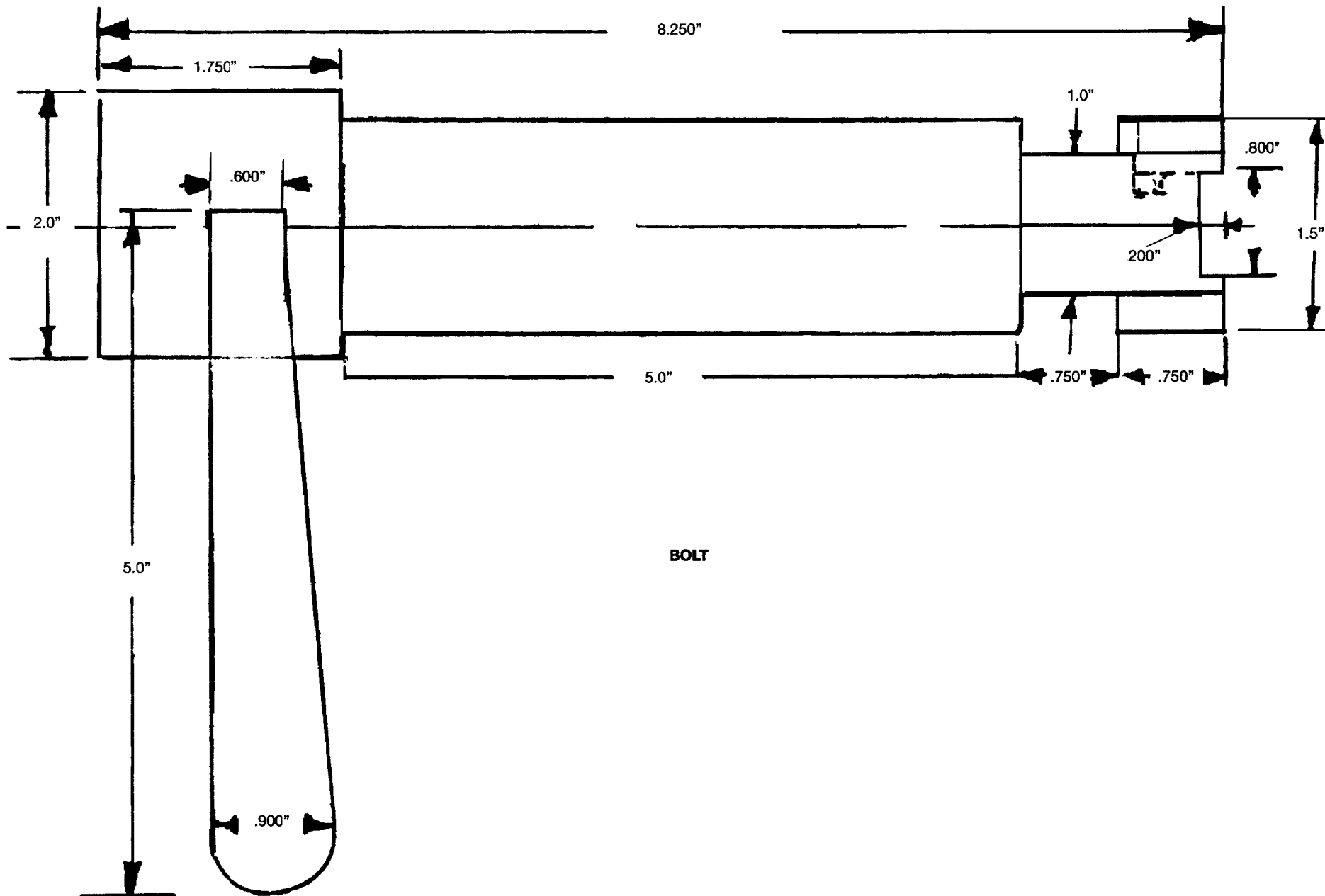

BOLT

BOLT

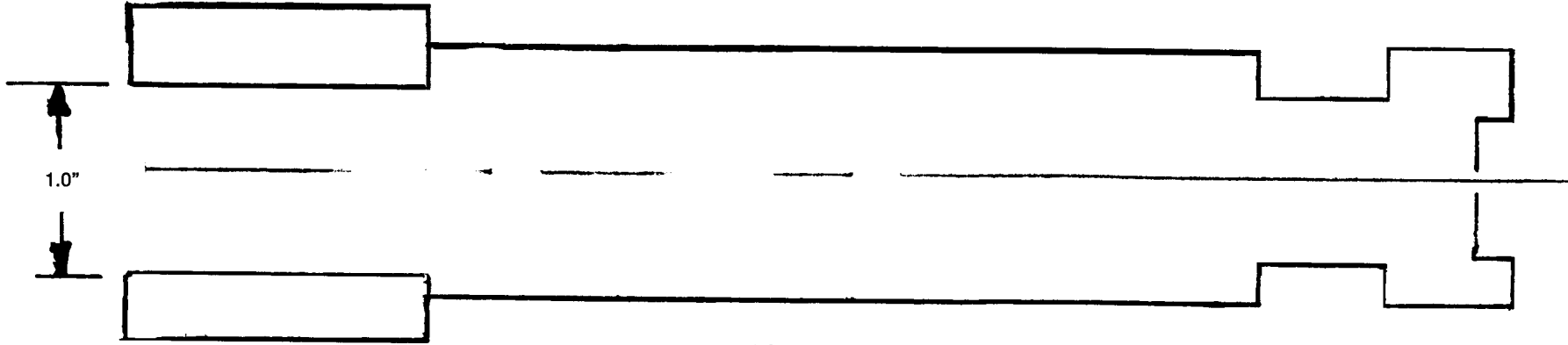
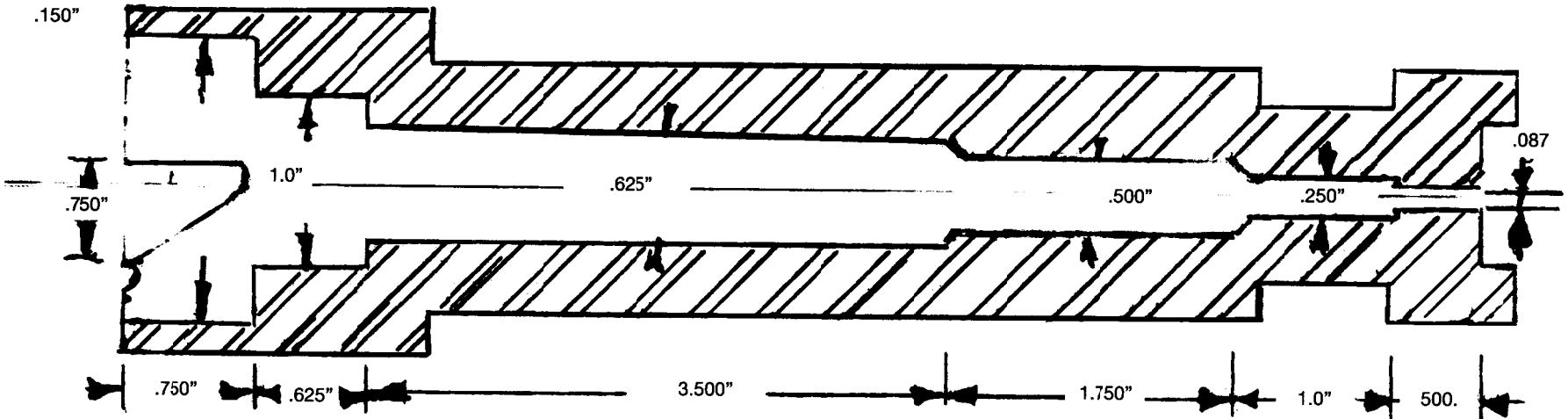

BOLT

THE .50-CALIBER RIFLE CONSTRUCTION MANUAL

UPPER RIGHT BOLT LUG, FROM FRONT

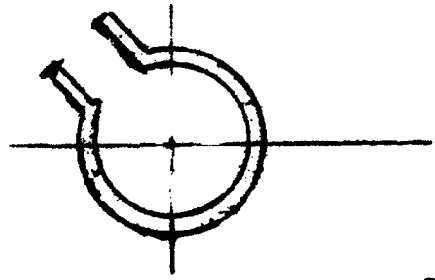
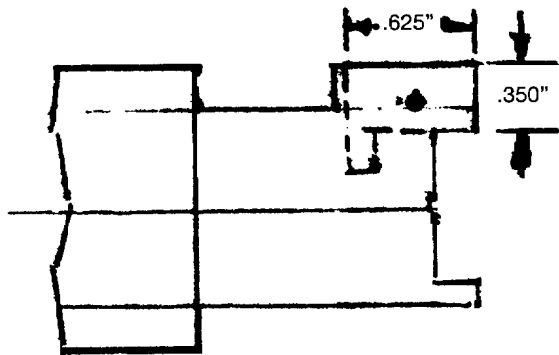

.187" SPRING POCKET

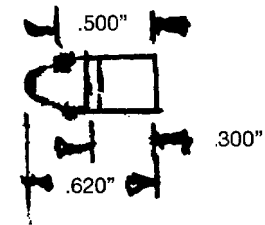
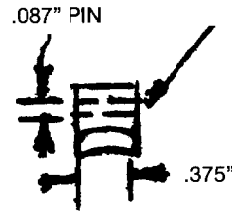
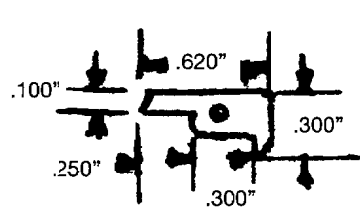
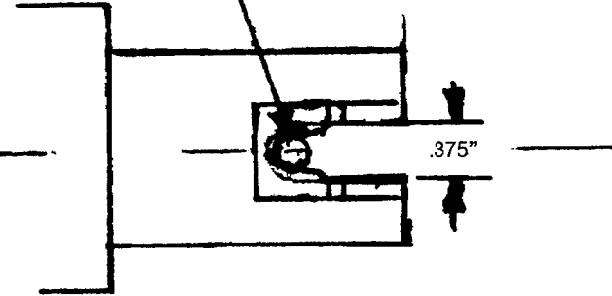

EXTRACTOR

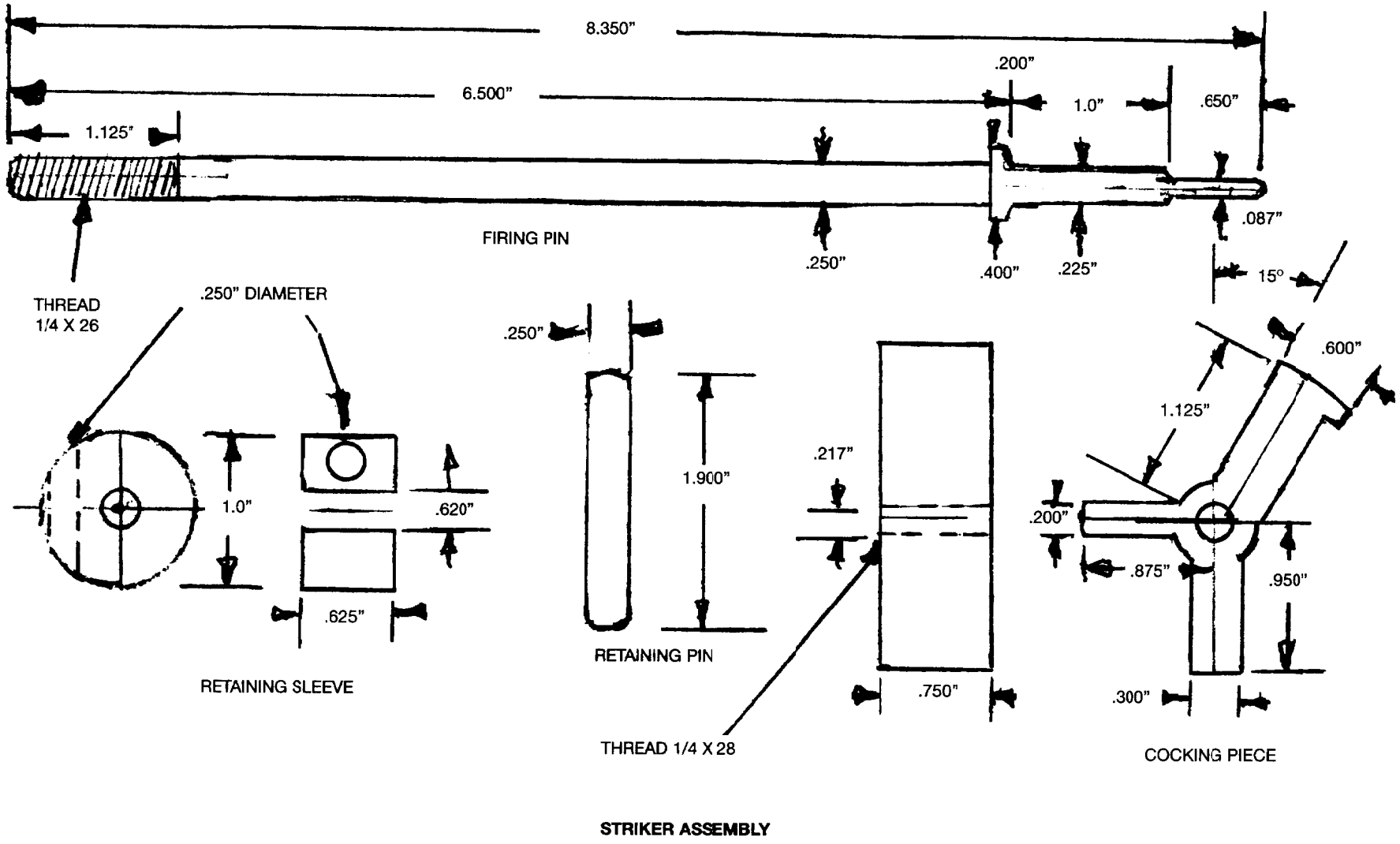



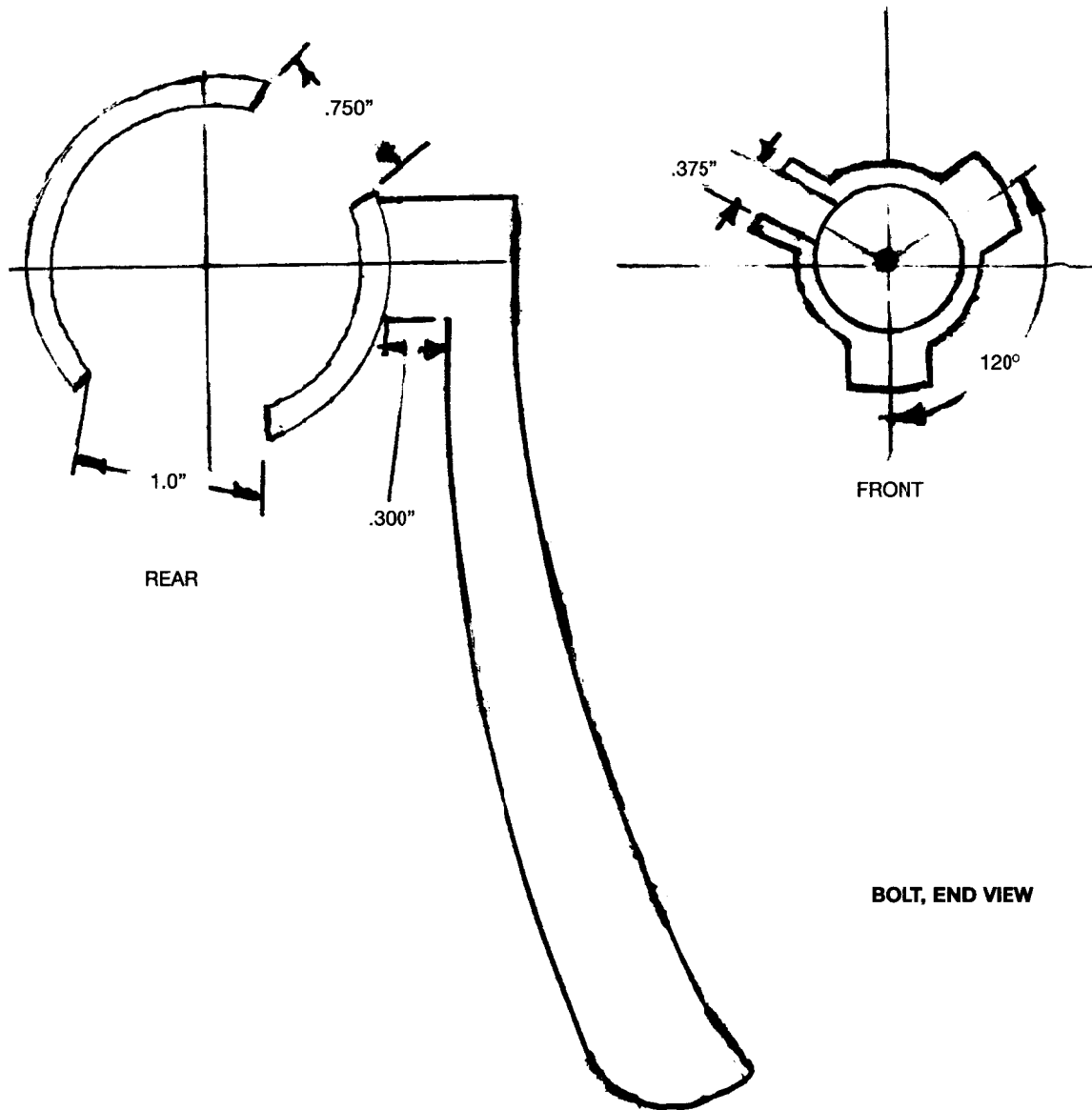

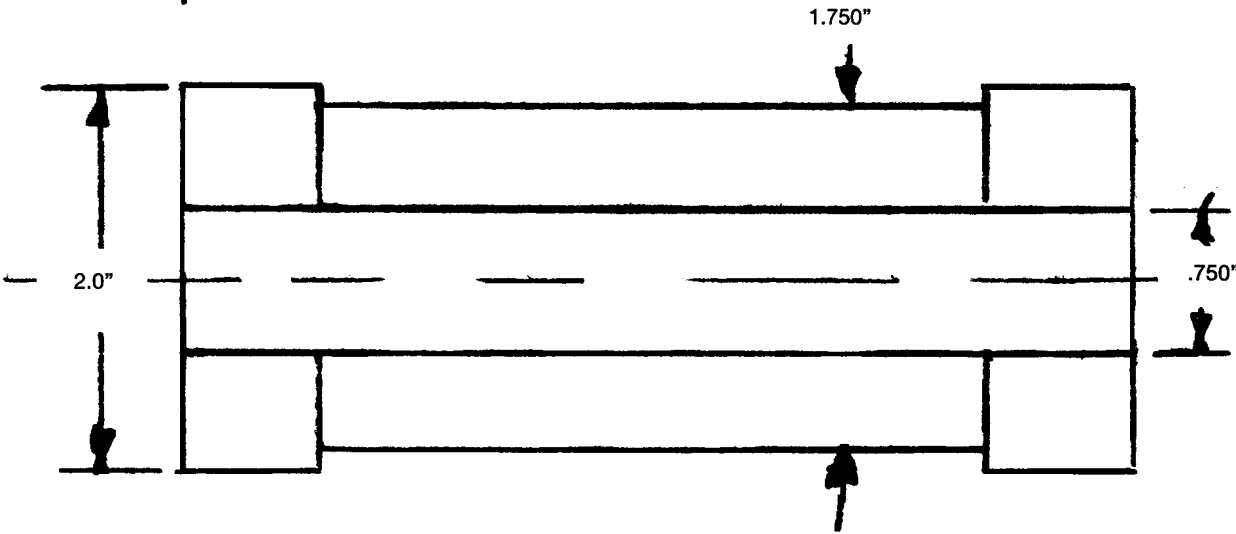
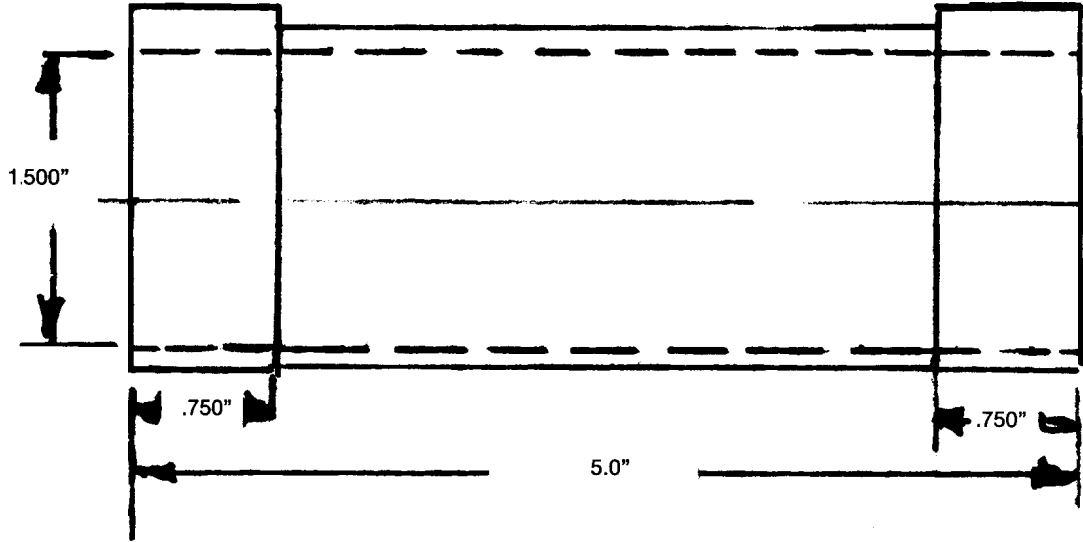

BOLT SLEEVE

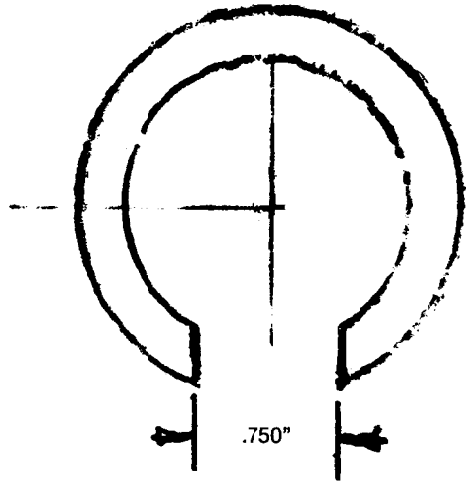

# TRIGGER ASSEMBLY

A mounting bracket for the trigger and sear to hinge from is made by milling a slot through a piece of 5/8-inch (.625-inch) square material that is contoured on the upper side to fit closely against the receiver body. It is then silver-soldered or welded in place.

Both the trigger and sear should be cut to the approximate shapes and dimensions shown. Some fitting may be required before these parts work as desired. It is a good idea to drill the pivot pin holes through the mounting bracket first and then put the trigger and sear in place and mark the hole locations through the previously drilled holes. This can save some fitting.

The trigger housing is made by forming 14-gauge sheet metal around a block and welding the ends and trigger guard in place.

The trigger guard could be bent to shape from a sheet-metal strip and welded in place, but the milled-steel guard, made similar to the one shown, looks quite a lot better.

There are those who would have you believe that a safety is not necessary on a single-shot firearm. If you are of this mind-set, then by all means leave it off. If, like me, you want to be pretty sure that the sear won't slip off and cause the rifle to fire as the bolt closes or otherwise fire when you don't want it to, then you should take a little extra time and add a safety.

The grip is made from a hardwood block and can be left in its natural color with a clear finish or painted black, whichever suits you best.



Trigger and sear.

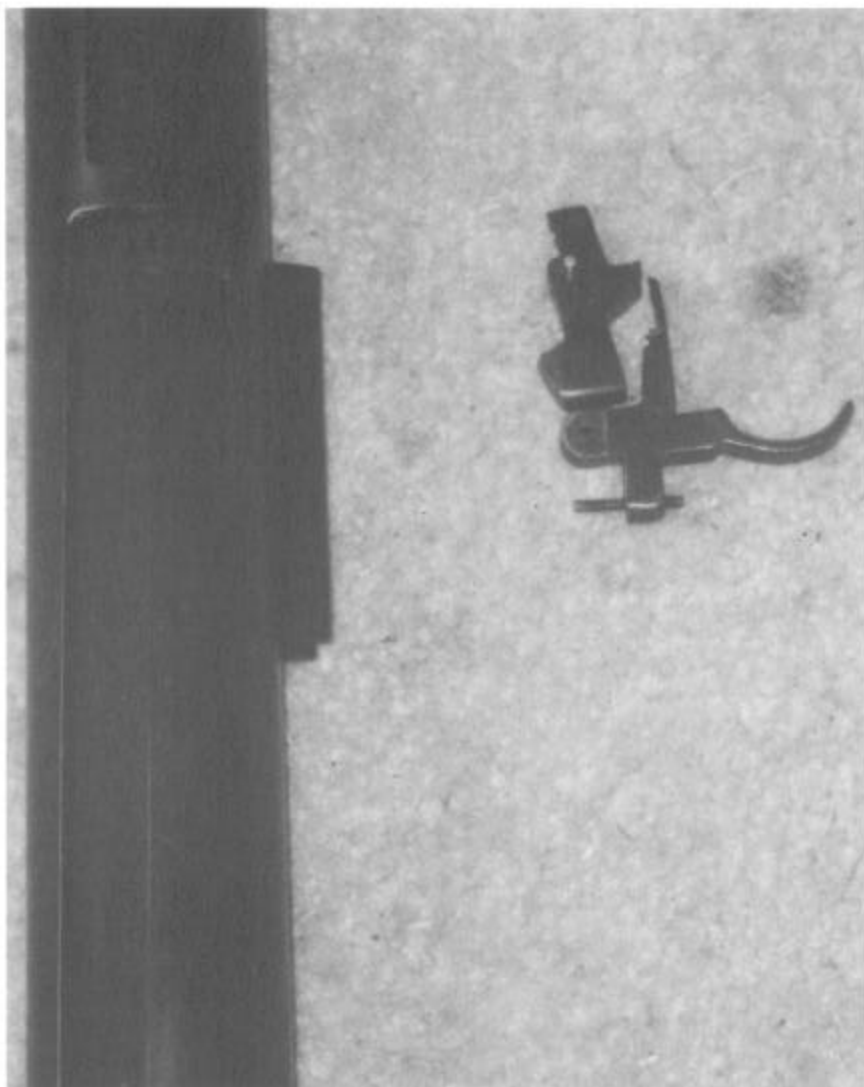

Trigger and sear ready for mounting.



Trigger housing.





Trigger housing, bottom view.

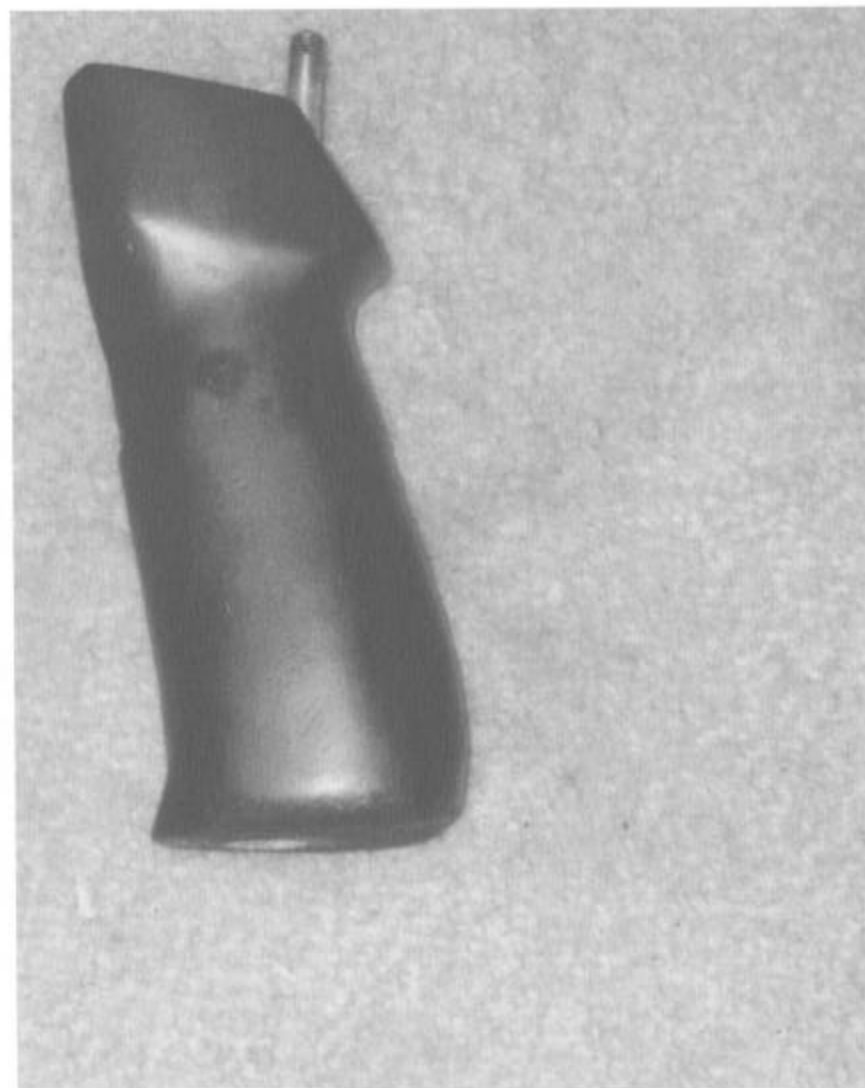

Grip.

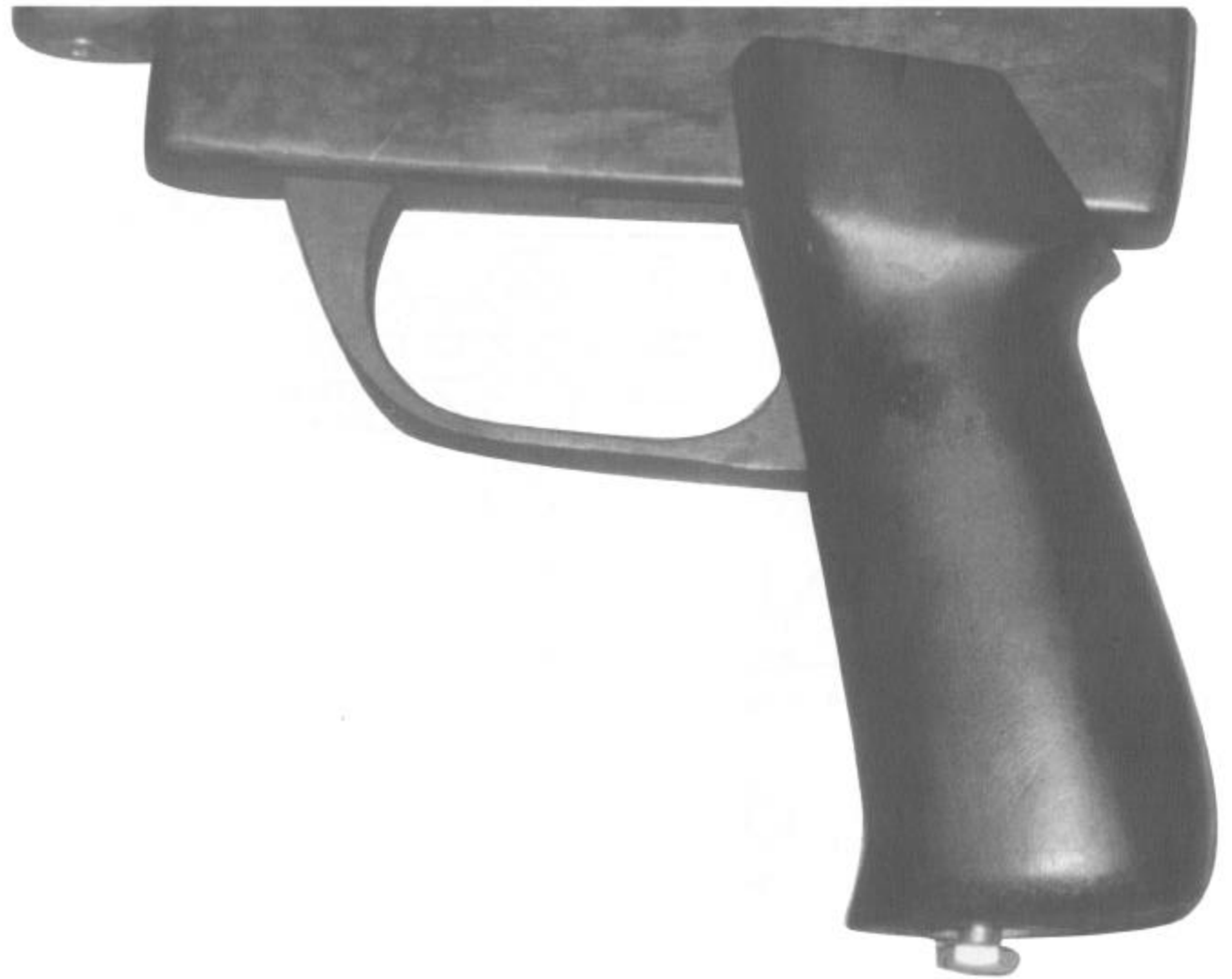

Grip and trigger housing assembled.

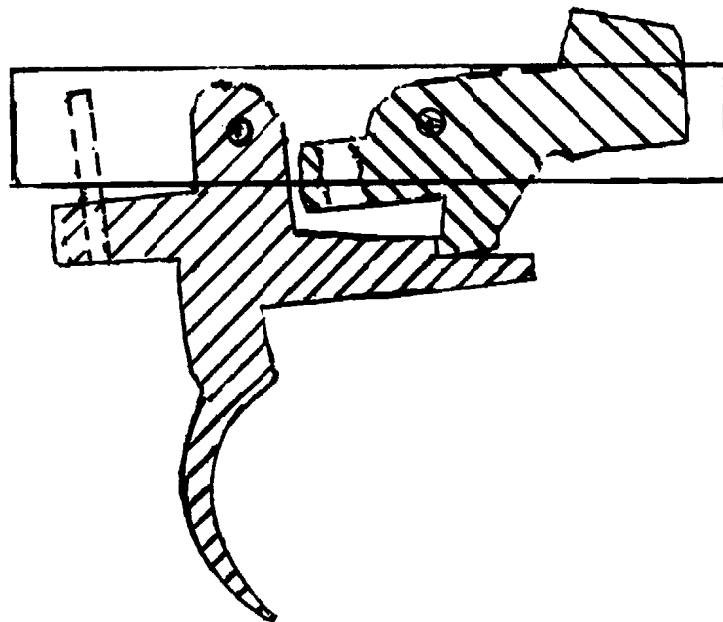

TRIGGER, SEAR ASSEMBLY

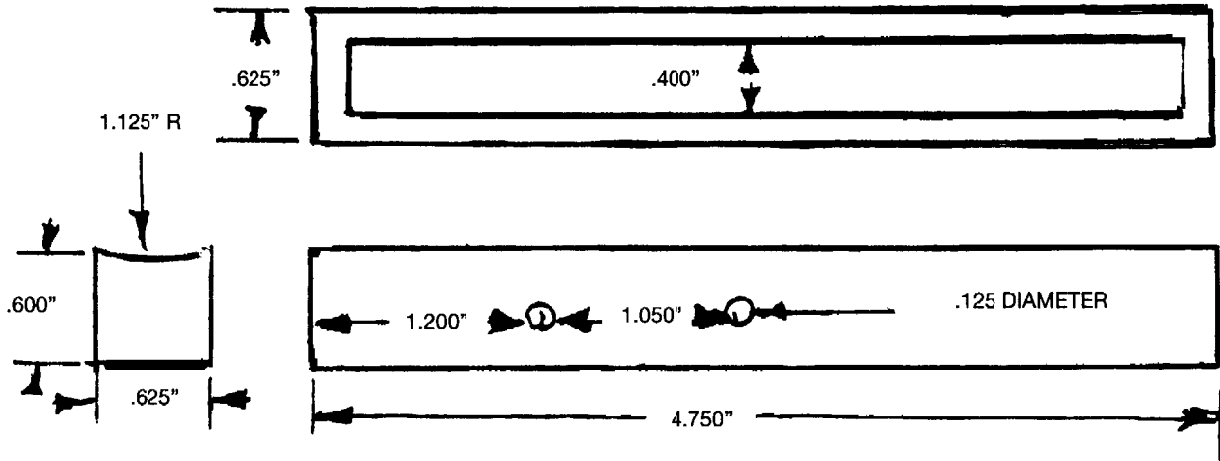

6 X 40 TPI

$.125''$  DIAMETER

$.250$  SPRING

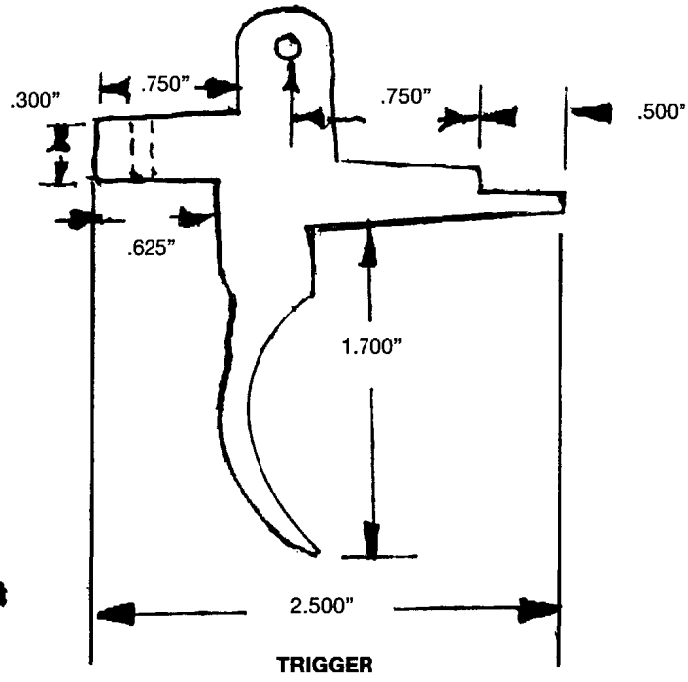
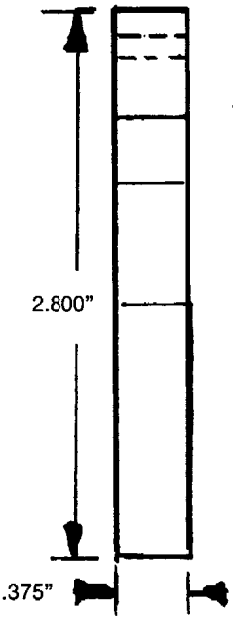

TRIGGER

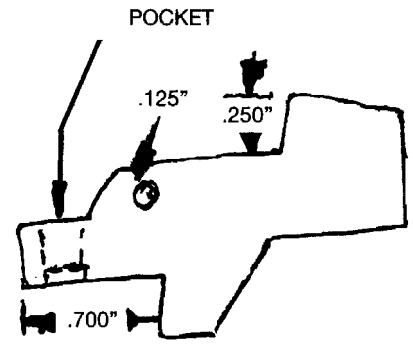
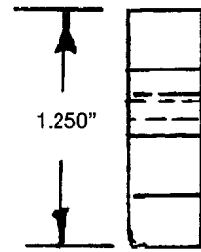

POCKET

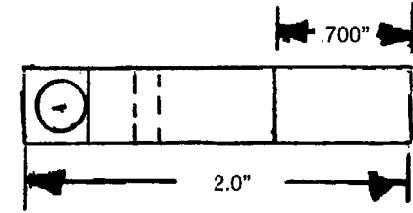

SEAR

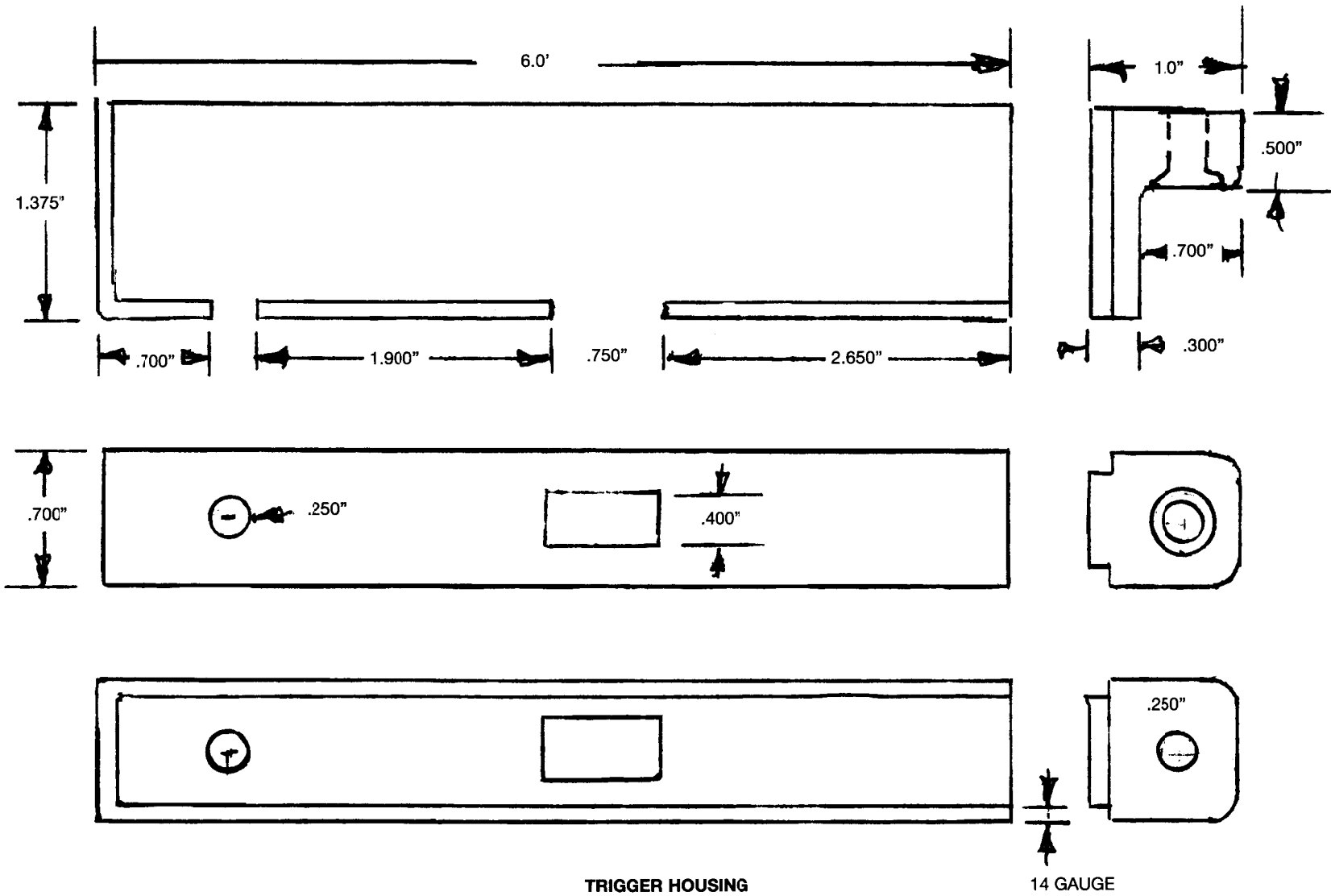



TRIGGER ASSEMBLY

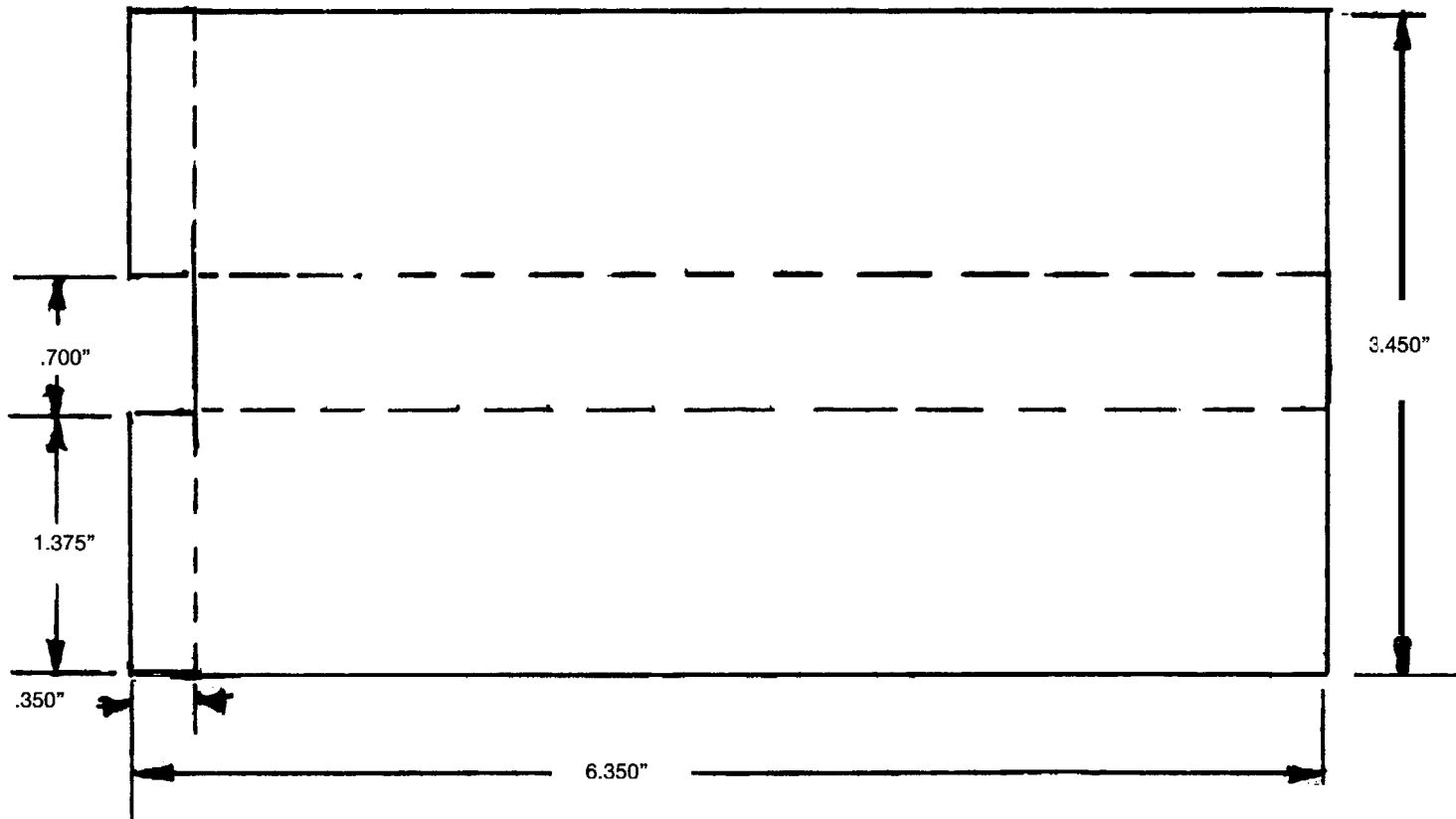

TRIGGER HOUSING PATTERN

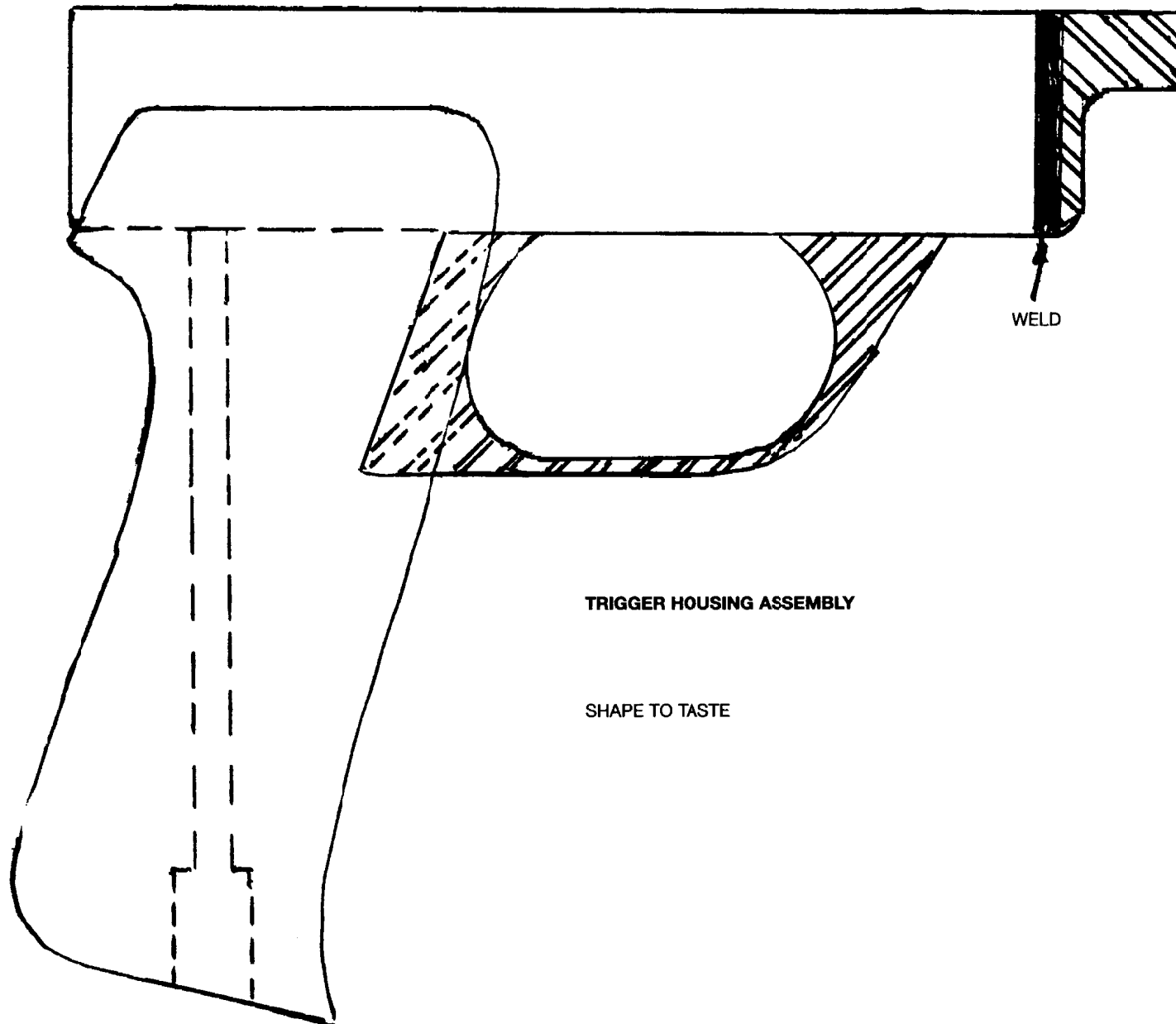

TRIGGER ASSEMBLY

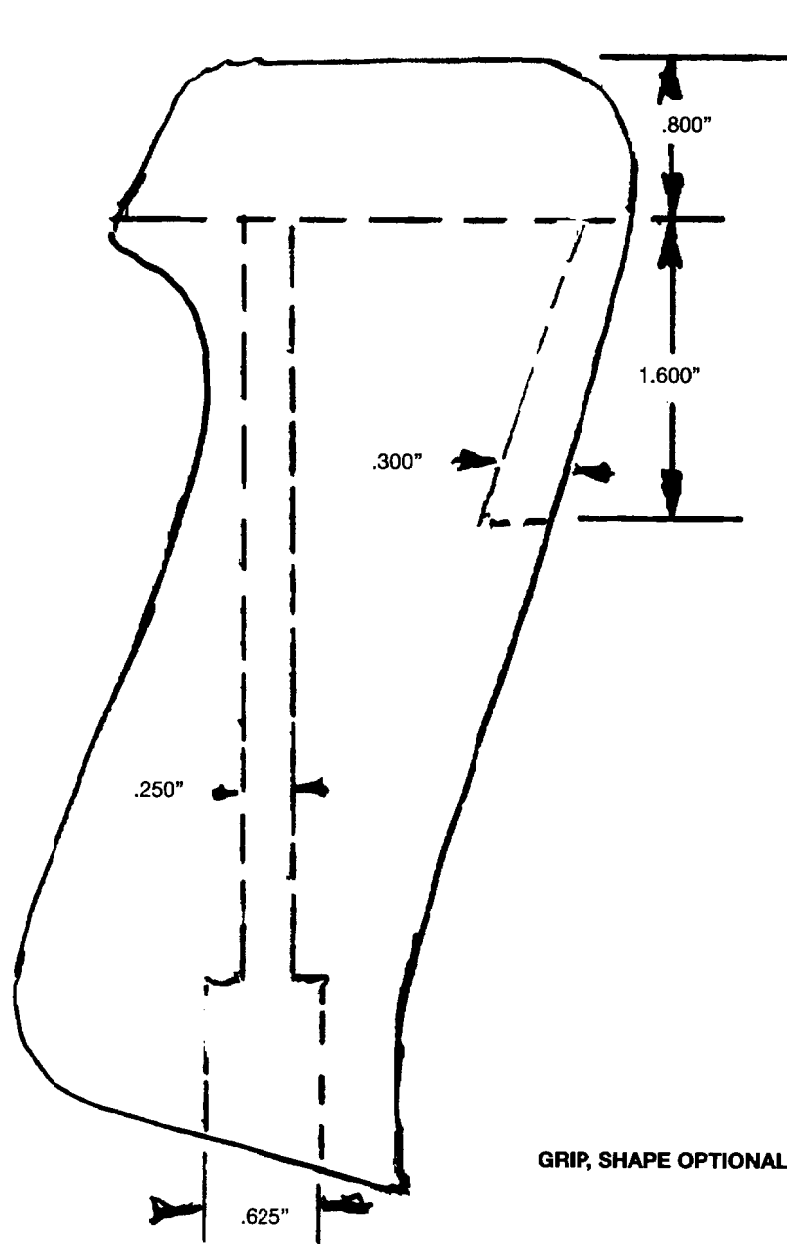

GRIP, SHAPE OPTIONAL

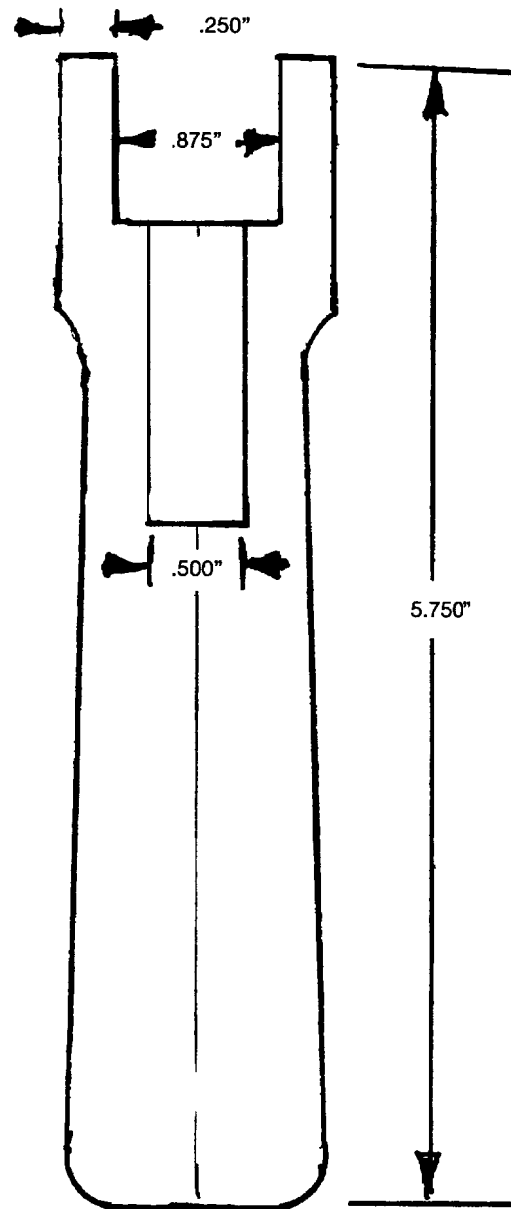

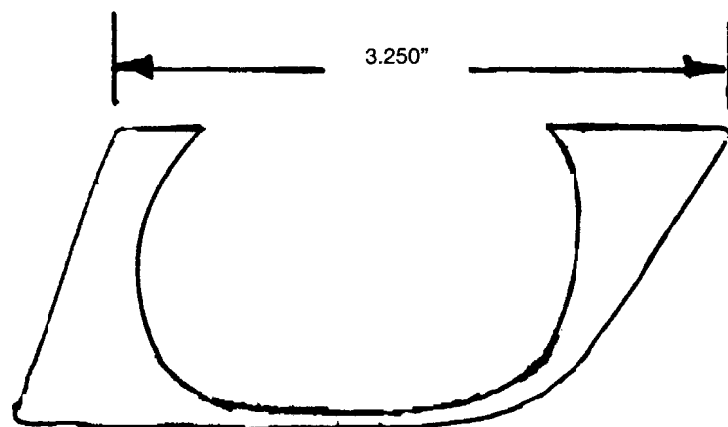

SHAPE AS DESIRED

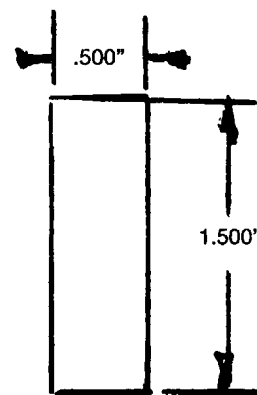

TRIGGER GUARD

# BUTTSTOCK

The buttstock is simply a section of 2-inch-outside-diameter tubing with a mounting plate for a recoil pad made from 12-gauge sheet metal and welded to one end. This is inserted in the receiver body, and the holes are drilled through both parts in the same operation. This should be done before the bolt slot is cut completely through the rear end because, as mentioned before, the tubing has a tendency to spring open slightly when it is cut completely through and the tension released.

The top-side bolt holes should be enlarged to accept a threaded bushing that, while acting as a nut, gives more thread depth than is possible with the tubing alone.

The biggest recoil pads I have been able to find are 2 inches

wide and 6 inches long. These are made by Pachmayr, and the only thing wrong with them is that they cost about as much as some rifles and pistols. This pad, or whatever other type you choose, should be bolted to the mounting plate and the plate dressed to match the contour of the pad.

If desired, a bracket can be silver-soldered to the lower end of the mounting plate and a brace, or stiffener, bolted both to it and the bottom of the grip. This strengthens both the grip and buttplate. Although not necessary or even desirable if the rifle is to be used as a target or bench rest rifle, it could be a worthwhile addition if the rifle is intended for use in field or combat situations.

THE .50-CALIBER RIFLE CONSTRUCTION MANUAL

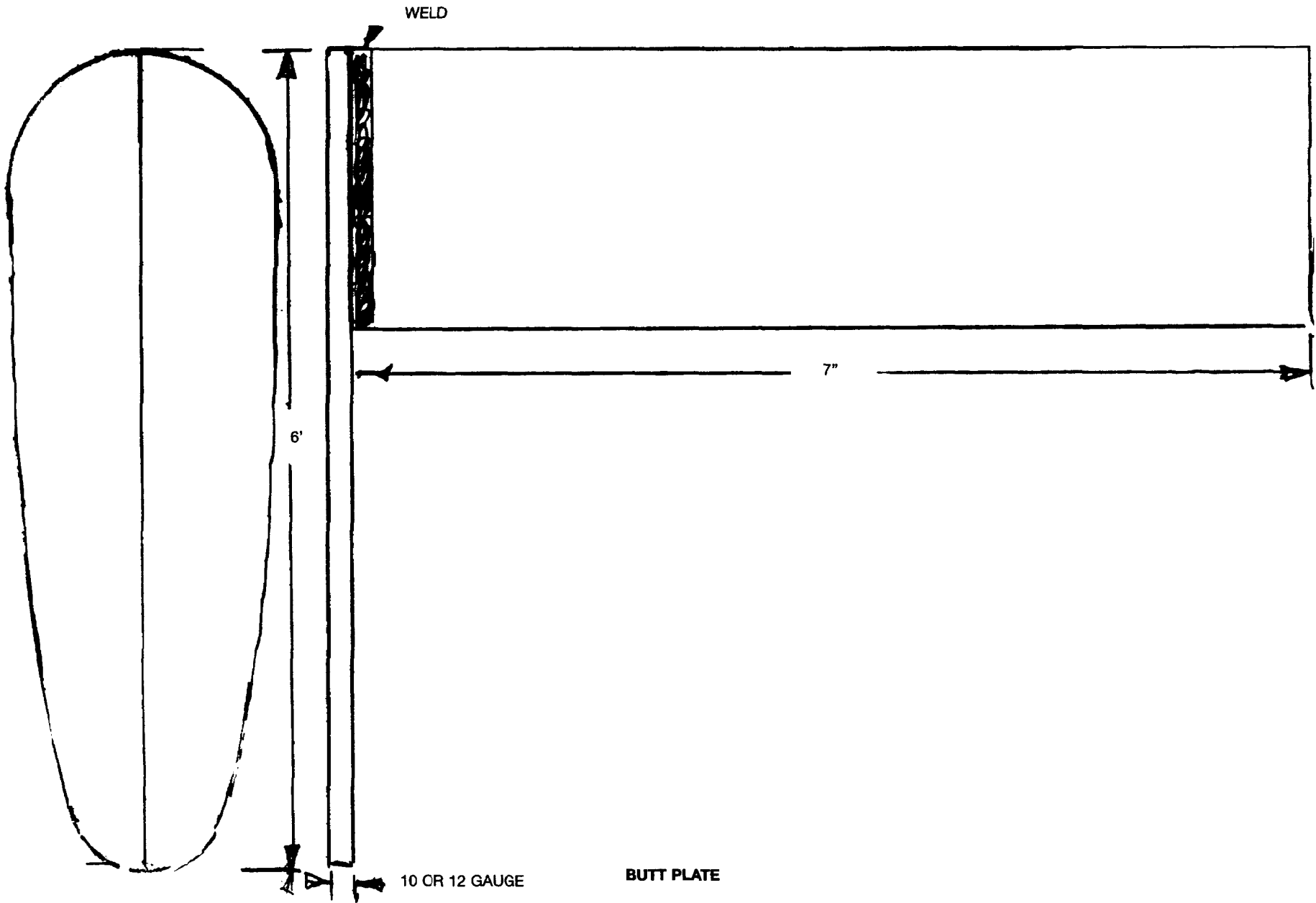



# SCOPE MOUNT

A base to mount the scope on (which will raise the sight line approximately 1 inch higher than is usual on a standard rifle) must be constructed. Even though this .50-caliber rifle generates no more recoil than most other large-caliber rifles, this base should be solid and sturdy.

Two short steel sections should be contoured to fit against the receiver tube and silver-soldered in place atop the receiver in the location that the bases will occupy. These simply add thread area as they are drilled and tapped through both these and the receiver.

Two steel blocks are contoured to fit the receiver tube, and a slot is cut down the center of each to fit over each of the reinforcing bars described above.

Depending on the scope bases you intend to use, a connecting

bar is made to accept it and silver-soldered to the top of the elevating blocks. The one shown in the drawing is for use with Weaver-type rings; if the steel rings used are of the same type as those made by Redfield and others, a sturdy mounting system is ensured. If other types of rings are used, they can simply be screwed to the blocks as they would be on a standard rifle.

This base should be drilled to accept four screws and clamped in place and the mounting screw holes drilled through the receiver. They are then tapped to accept proper screws. I recommend using 10 x 32 screws for this.

Be sure that you have enough eye relief to avoid being hit in the eye with the scope when firing. Try to mount the scope as far forward as possible while retaining a complete field of view.



Scope and mount in place on rifle.

SCOPE MOUNT

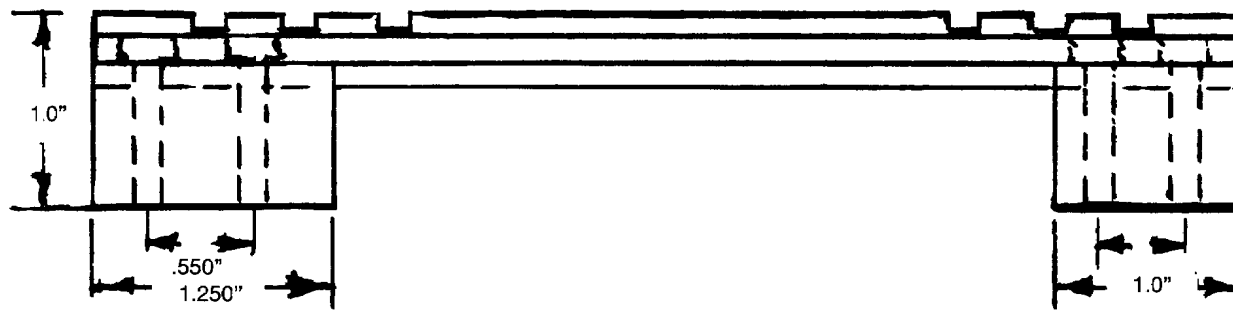
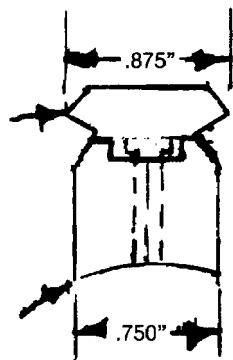
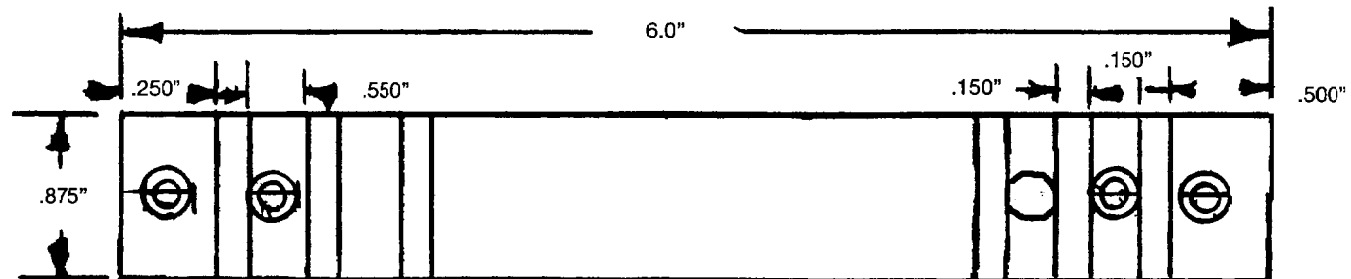

SCOPE MOUNT

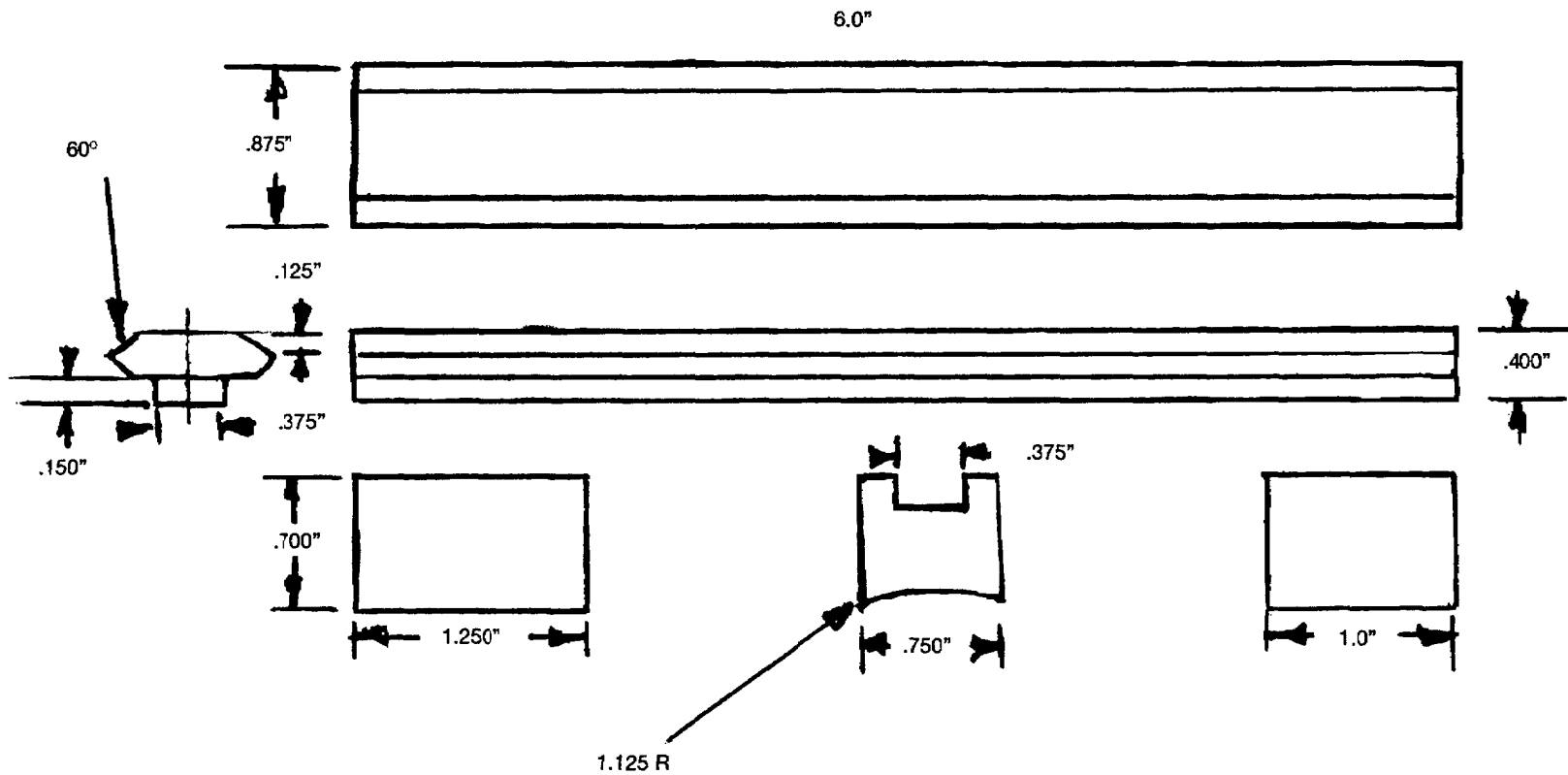

SCOPE MOUNT COMPONENTS

# BIPOD

A rifle such as this produces quite a lot of torque, or twisting, to the right when fired, so a sturdy bipod is in order. It would be nice if one could simply obtain one of the ready-made ones and mount it in place. The trouble is, there are simply no satisfactory ones available—at least not that I know of.

The center section, which mounts at the front end of the receiver and is held in place with screws, is machined from 2-inch round stock. This should be contoured to a close fit with the receiver and a bar silver-soldered over the mounting position and drilled and tapped just like the scope-mount screw holes were.

The hinged ends of the legs are made from the same 2-inch round stock, with the legs made from .065-inch-wall-thickness

seamless tubing welded in place. The lower ends can be shaped as shown or modified as desired and pinned or welded in place.

A template should be made to locate the locking pin holes. To be effective these holes must line up exactly. If they don't, there is a good chance that the bipod will collapse when the rifle is fired.

The spring-loaded detent, or locking, pins are made from drill rod with the push buttons silver-soldered in place.

In use, the button is pushed in and the leg extended or folded against the receiver, where it will lock in place when the hole and pin line up and the spring forces the detent pin into place. This process is repeated on the other side to place both legs in the same position.



Bipod ready for mounting.

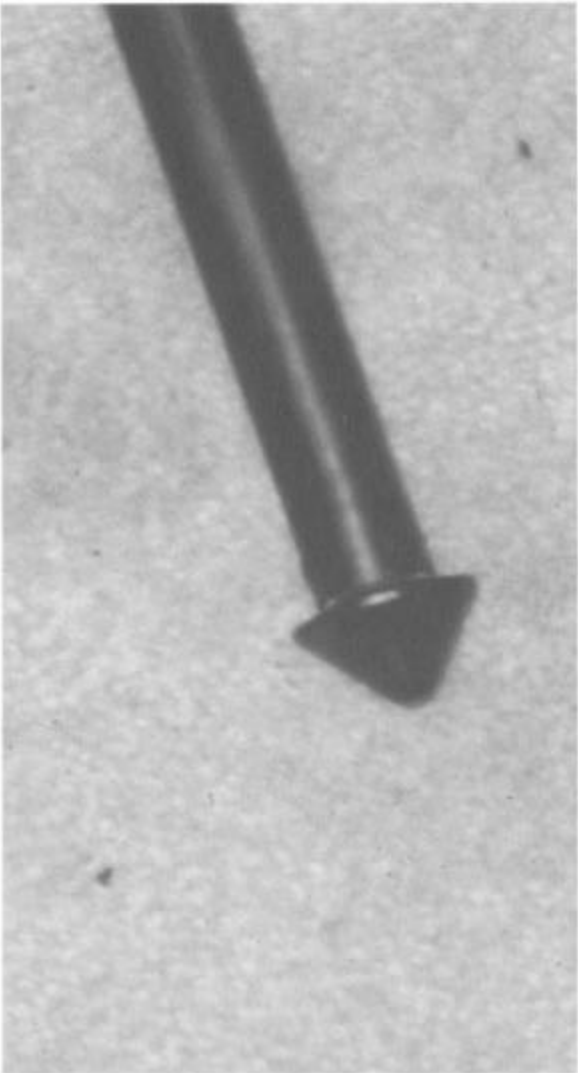

Lower end of bipod leg.

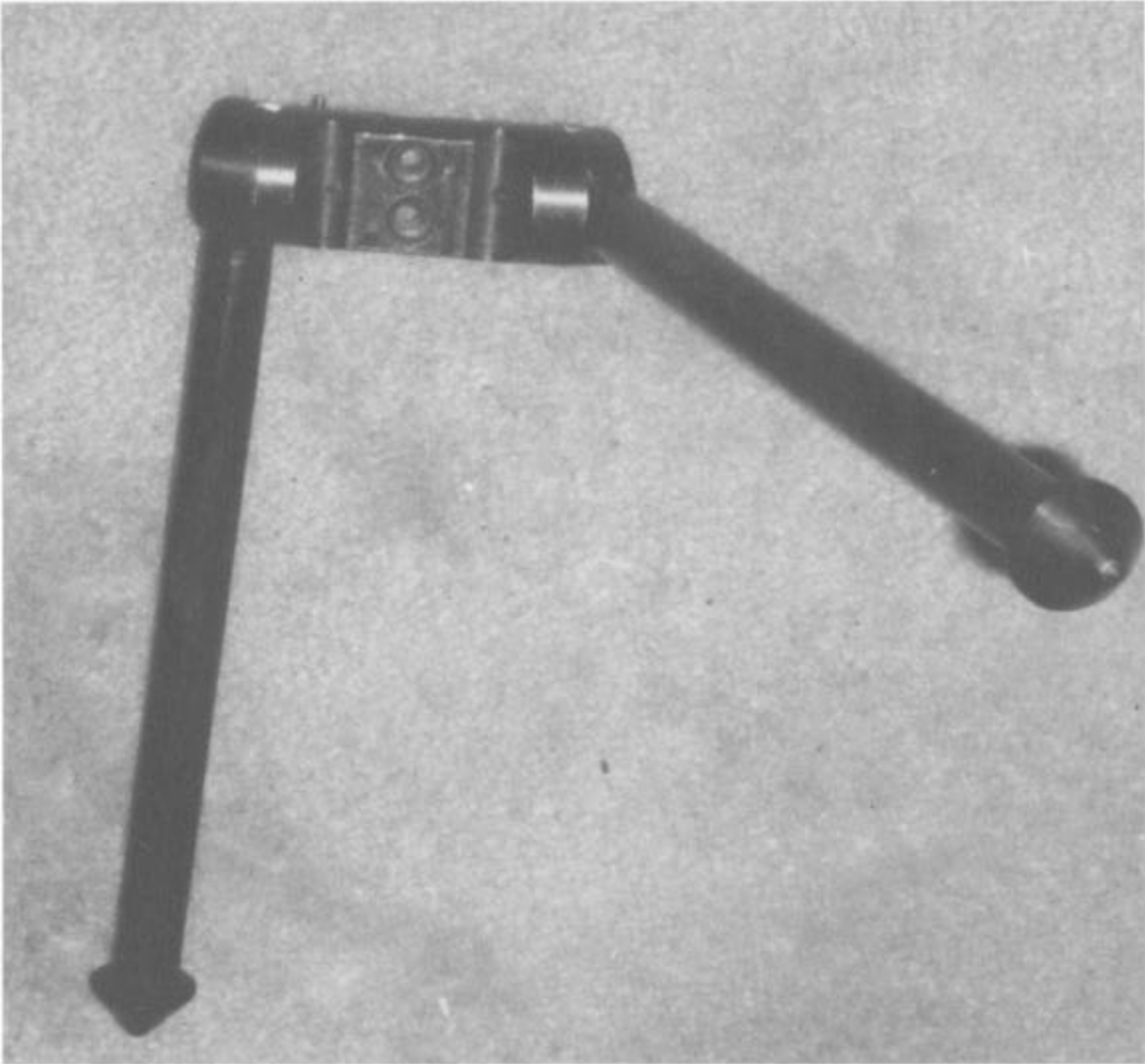

Bipod with right leg folded.



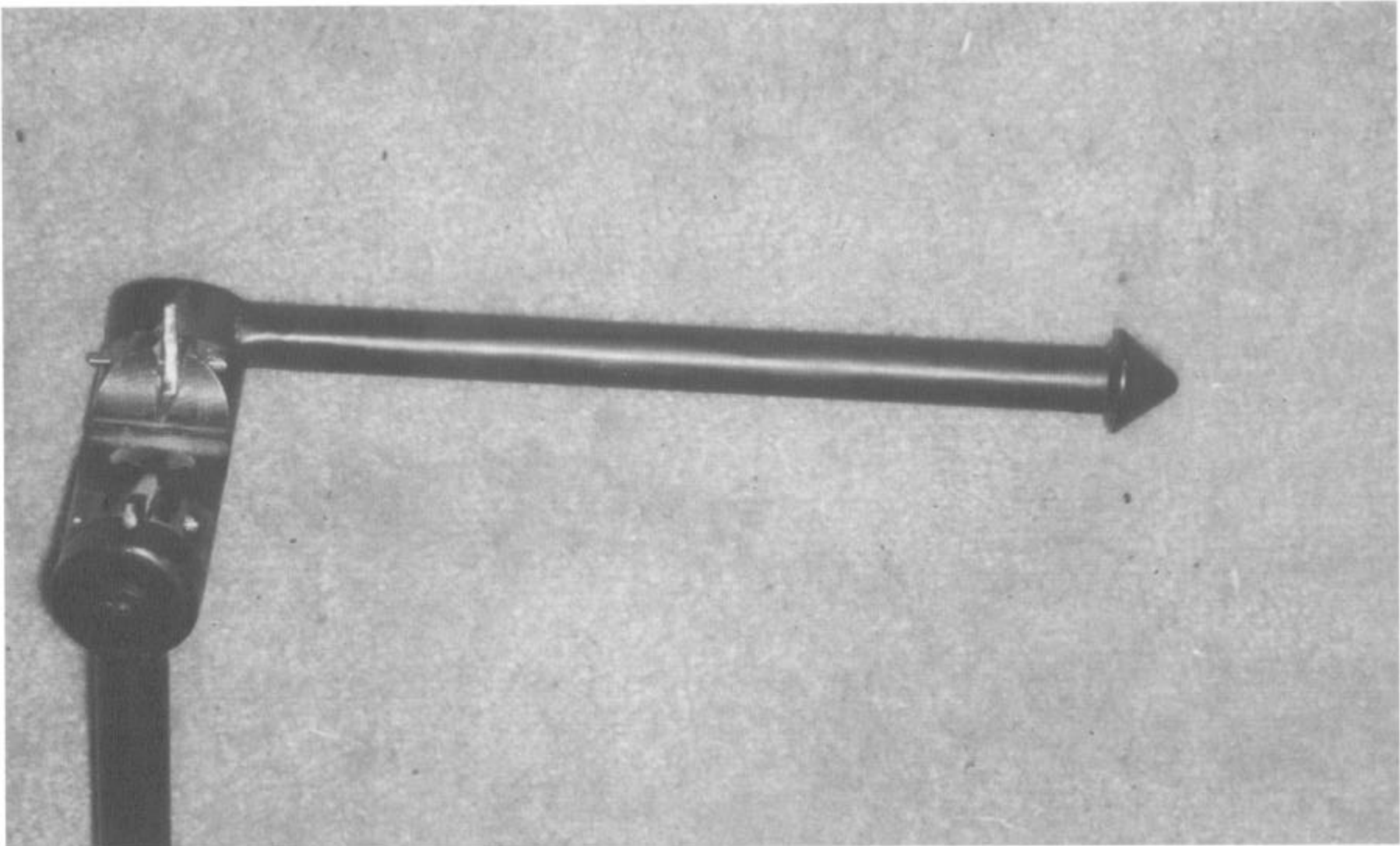

Side view of same.



Bipod mounted in place.



Finished bipod.

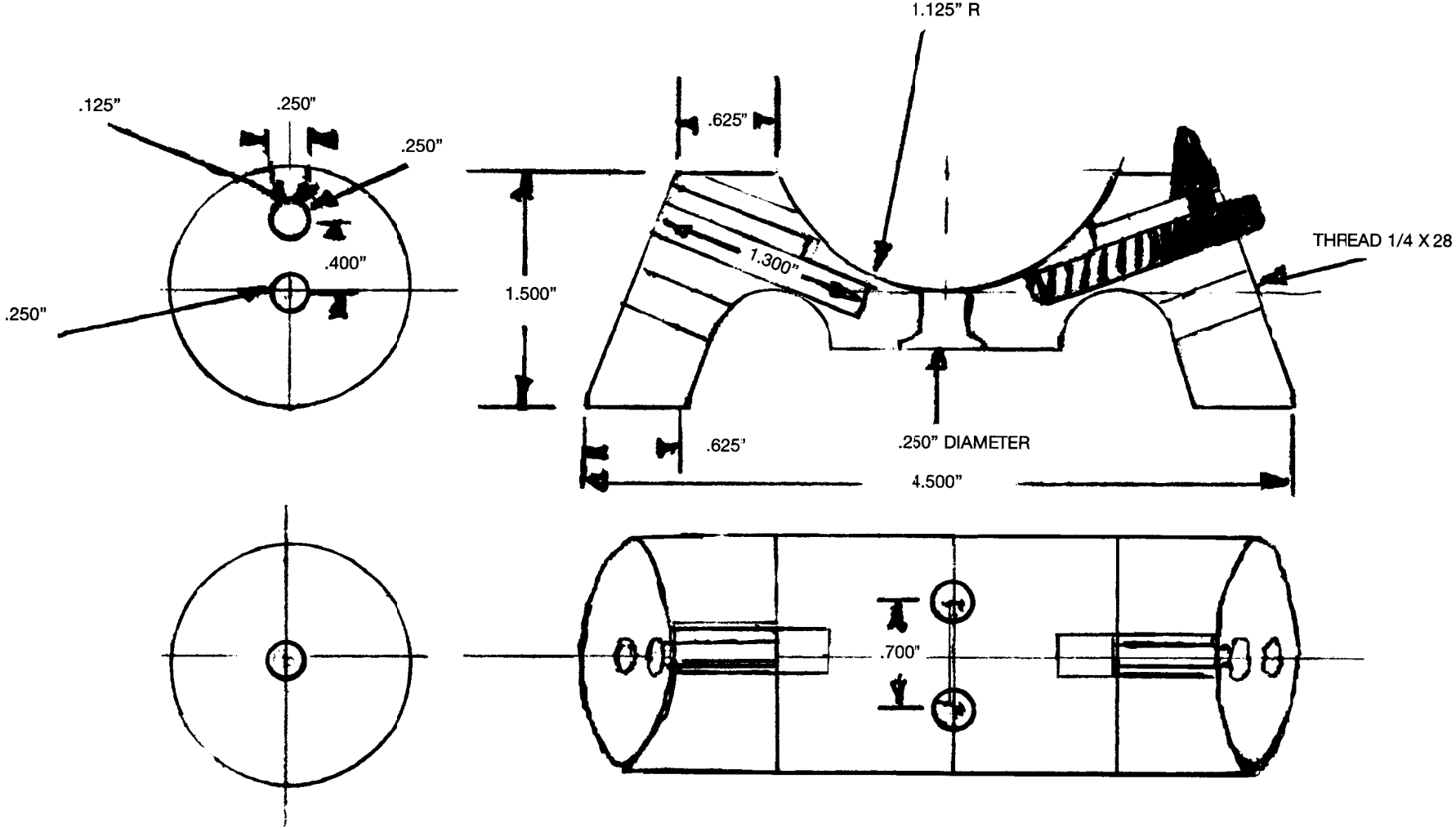

BIPOD, CENTER SECTION

THE .50-CALIBER RIFLE CONSTRUCTION MANUAL

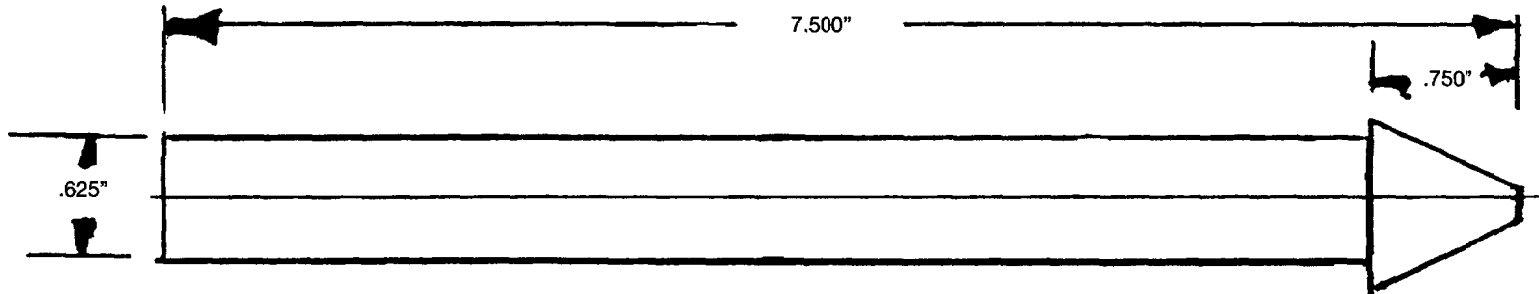
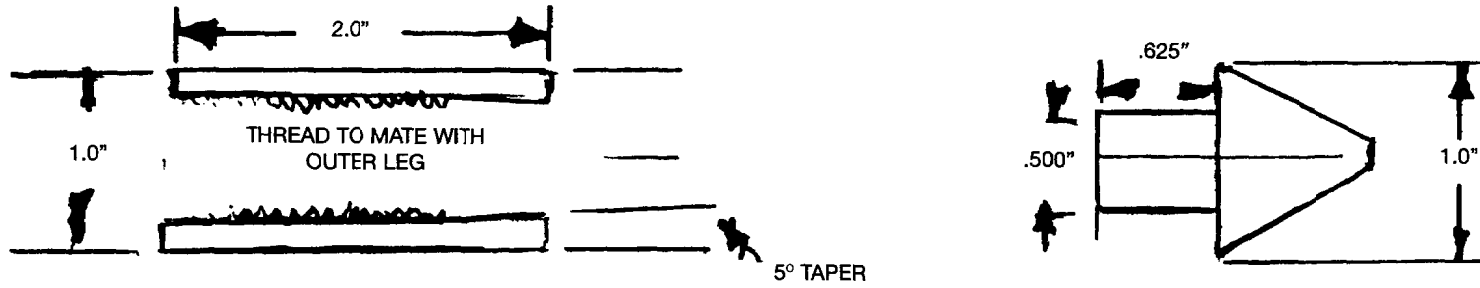

BIPOD, INNER LEG

BIPOD

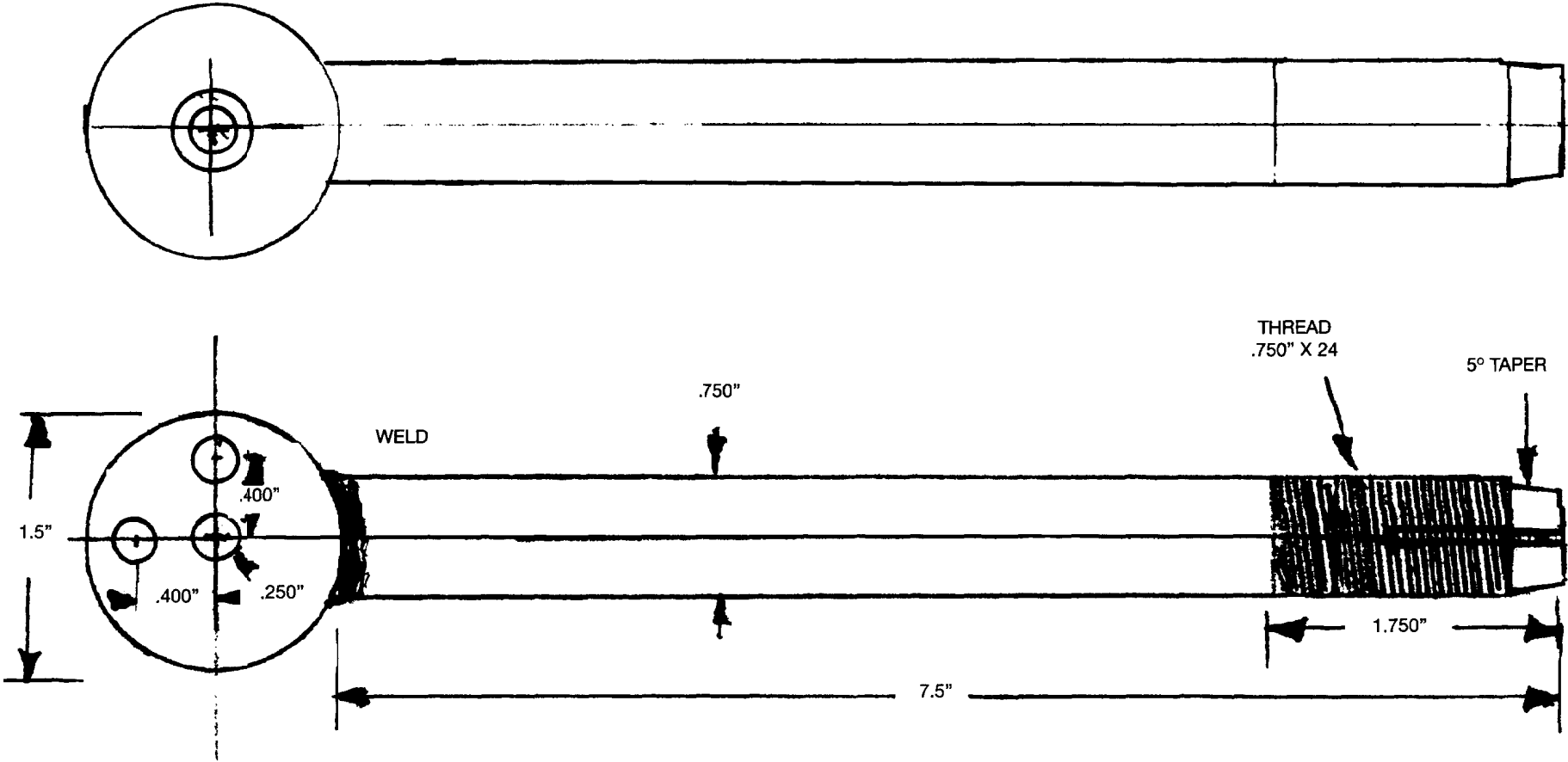

BIPOD, OUTER LEG

# MUZZLE BRAKE

The function of the muzzle brake is to reduce felt recoil. This is done by causing the gases that propel the bullet to push against the enlarged flat surface at the front end of the brake, which gives the gun a push forward while the bullet exits the barrel through a hole just slightly larger than the bullet diameter. Most of the gases are dissipated through a series of holes spaced around the brake body.

The brake design shown here has served me well on a number of homemade firearms and reduces recoil as well as or better than others I have experimented with. This opinion is not mine alone; it is shared by several others who have used these same rifles.

Construction of the muzzle brake described is begun by inserting a section of quality steel, 2 inches in diameter and 5 1/2 inches long, in the lathe chuck. A hole, 1/2 inch in diameter, is bored lengthwise completely through the material using a new, sharp drill secured in the tail stock. It is then enlarged to a diameter of 1.100 (one and one-hundred-thousandths) inches and to a depth of 5 1/4 inches. This will result in a wall for the gases to push against at the forward end of the brake. A 3/4-inch (.750-inch) length is left at the extreme rear of the brake to be threaded to mate with the barrel. The length forward of this and stopping at the front wall should be bored to a diameter of 1 1/2 inches (1.5001 inches) with

the same boring bar used for the other components.

The smaller section at the rear is now threaded with 12 TPI by 1.300 (one and three-hundred-thousandths) inches. This part should be threaded before the barrel threads are cut because if any recutting is required it is far easier to pick up an outside thread. This thread joint should be a snug fit with little or no play between the threads to ensure that the exit hole in the brake remains in alignment with the barrel bore.

The threaded end should be caught in the chuck, the tail stock center placed in the exit hole, and the fins turned on the outside as shown. I admit that these fins are mostly cosmetic, but they do reduce recoil slightly.

Six rows of half-inch holes are spaced and drilled equidistant around the circumference of the brake body. If no mechanical spacer is available, these can be located by using the tape method described earlier.

The barrel is again mounted in the lathe, and the thread is cut to attach the brake. As mentioned previously, the thread joint should be a snug fit with some effort required to screw it home. Tightening it can be accomplished by using a 1/2-inch bar pushed through the vent holes and used as a wrench.



## THE .50-CALIBER RIFLE CONSTRUCTION MANUAL

The exit hole must be bored slightly larger than the bullet diameter (.510 to .520) inch. To ensure concentricity, this is done while the barrel is still in the lathe. If any misalignment is present, the bullet may rub one side of the exit hole, resulting in poor accuracy.

It is also possible to fabricate a fairly efficient brake by welding a plug in each end of a length of seamless tubing and boring the

small exit in one end and threading the other. It may not look quite as good, but it is easier and faster to build than the one described.

Please note that the length and diameters shown are not absolute. You can probably build one shorter or longer or smaller in diameter with no ill effects. The sizes shown work for me, and I have never had occasion to change them.



Side view of muzzle brake.

**MUZZLE BRAKE**



End view of muzzle brake.

THE .50-CALIBER RIFLE CONSTRUCTION MANUAL

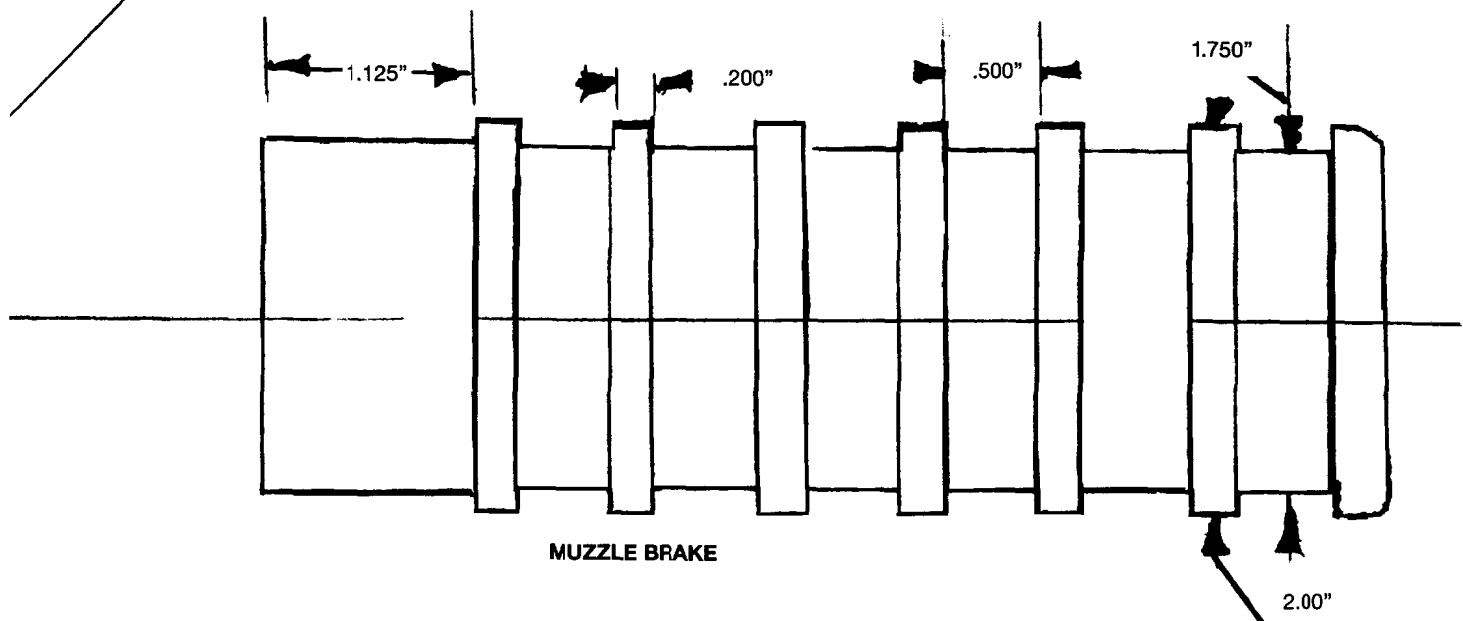
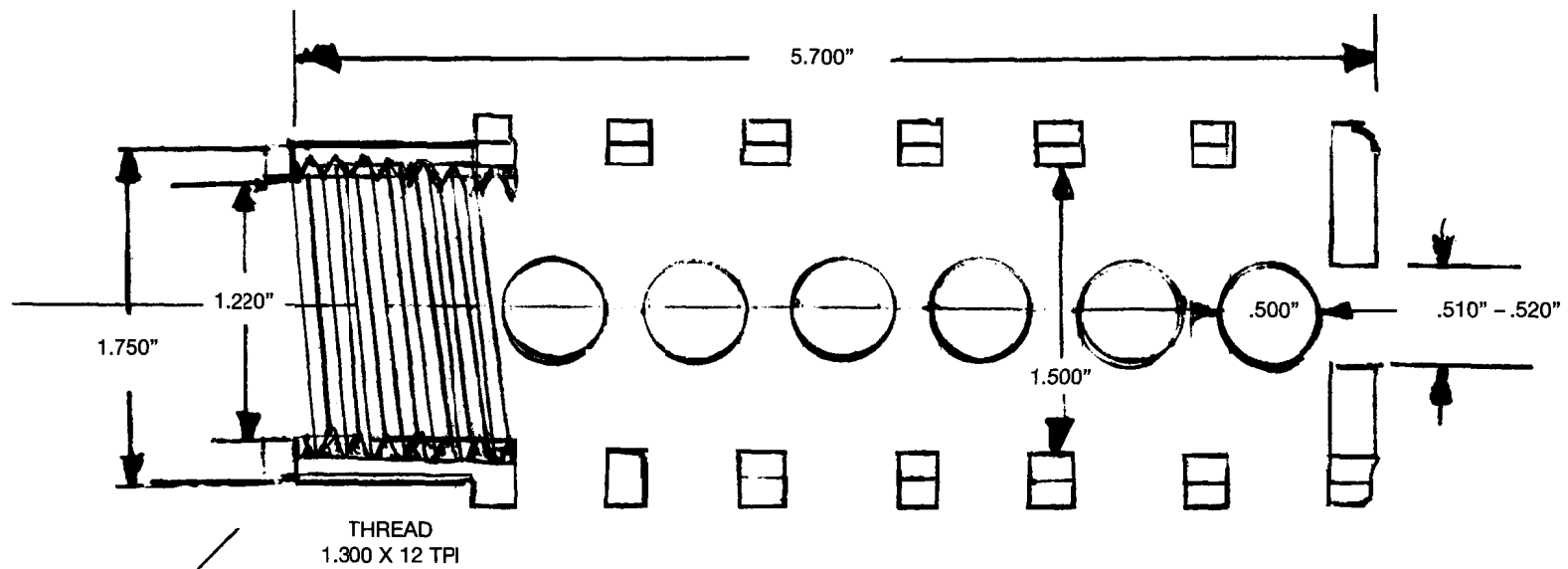

# ASSEMBLY AND FIRING

Assembly is begun by sliding the barrel in place through the rear end of the receiver and securing it by screwing the barrel nut as tight as possible. The muzzle brake is next threaded on the end of the barrel. Again, it should be as tight as possible.

The bipod assembly is now bolted in place, followed by the scope mount and trigger assembly.

With the bolt in place, the buttstock assembly is inserted into the rear end of the receiver and bolted in place.

Don't forget to bore the exit hole in the front end of the muzzle brake slightly larger than the diameter of the bullet and to screw the muzzle brake on as tight as possible. During the final assembly it is a good idea to apply Loctite or a similar product to the threaded joints of both the muzzle brake and the barrel extension.

The gun can now be test-fired. My own first gun was tied across a truck tire and fired by pulling a string tied to the trigger. Since nothing out of the ordinary took place, it was then fired several times from a bench rest. Headspace was then checked and found to be correct.

The gun was then disassembled and examined thoroughly for cracks and battering. Since all was as before, guns made after this were test-fired without any extra precautions and with no ill effects. Just because I have no better sense than to do this, however, that is no reason for you to do it too. Be careful.

While the gun is apart, final polishing of the parts is done and the parts are colored by bluing, painting, or whatever finish you like.

If using surplus military ammo you will soon discover that all rounds are not exactly alike in terms of dimension. I have found the U.S.-made Lake City and the Israeli-made cases to be fairly consistent, but some of the rest won't even go into the chamber. Remember, you have a precision-cut standard chamber cut to the correct dimensions, and cartridges used must fit the chamber, not vice versa. Do not try to force junk ammunition into the gun. Only trouble will result.

Also, I'd just like to reiterate that since the publisher and I have no control over materials or machining methods used by others, we cannot accept any responsibility for any misuse of this product or problems encountered in its construction or use.



**I**n this companion book to the best-selling *Home Workshop .50-Caliber Sniper Rifle* videotape, Bill Holmes takes you step-by-step through the process of designing and constructing your own .50-caliber rifle easily and inexpensively. Using full-scale fold-out drawings and precise dimensions, the master gun maker shows you how to make your own receiver, barrel and accessories, bolt, trigger assembly, buttstock, scope mount, bipod, and muzzle brake using commonly acquired materials. Once you have made all the component parts, Bill then instructs you in the right way to assemble and test-fire your new rifle.

**T**his is the book that do-it-yourselfers anxious to try building their own .50-caliber rifle have been demanding since the video first came out. It's for those hands-on people who prefer to have clear drawings and instructions to study and refer to before beginning any project. With Bill Holmes as your guide, construction of your own .50-caliber rifle is a snap.

**W**arning: It is *your* responsibility to make sure that you have complied with all local, state, and federal laws with regard to the manufacture of a firearm. The author, publisher, and distributor of this book disclaim any liability for the use or misuse of information contained herein. This book is *for academic study only*.

A PALADIN PRESS BOOK  
ISBN 1-58160-346-0



Visit our Web site at [www.paladin-press.com](http://www.paladin-press.com)